

PVC & ALUMINIUM
SHUTTER SYSTEMS

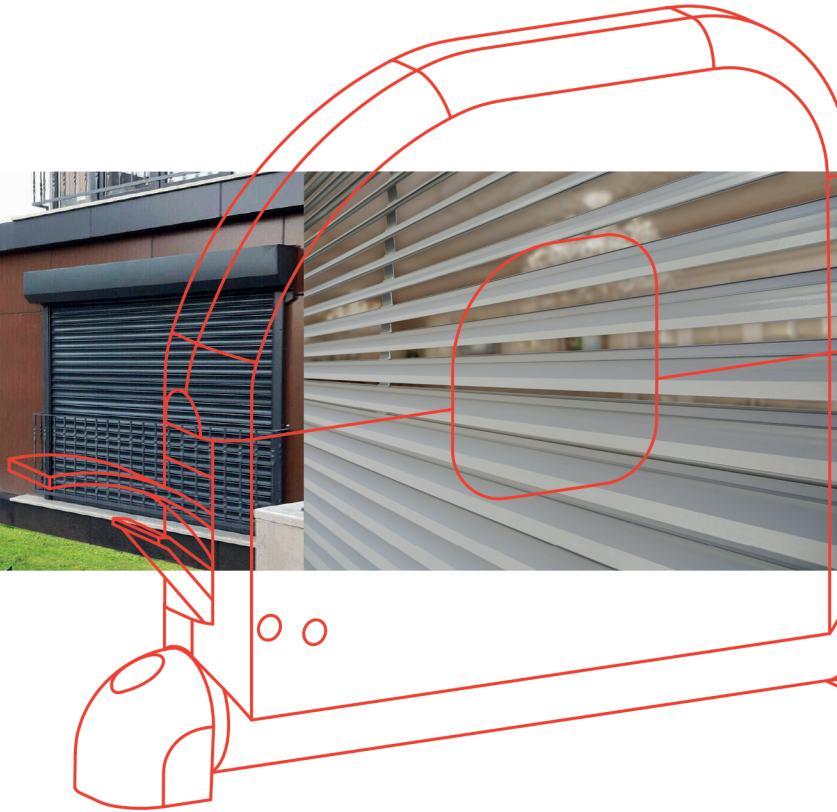
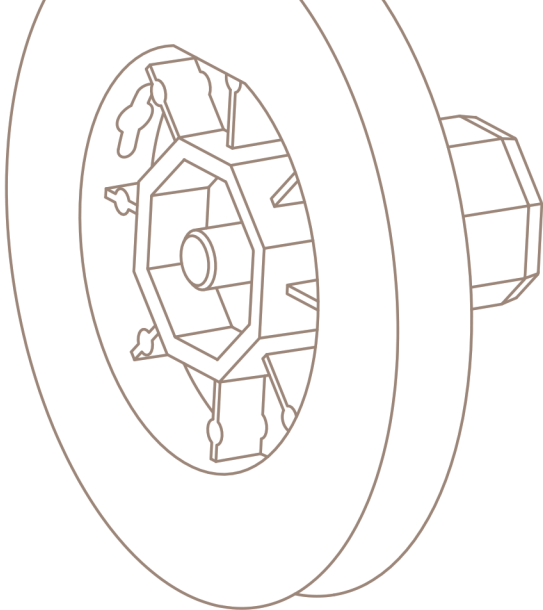
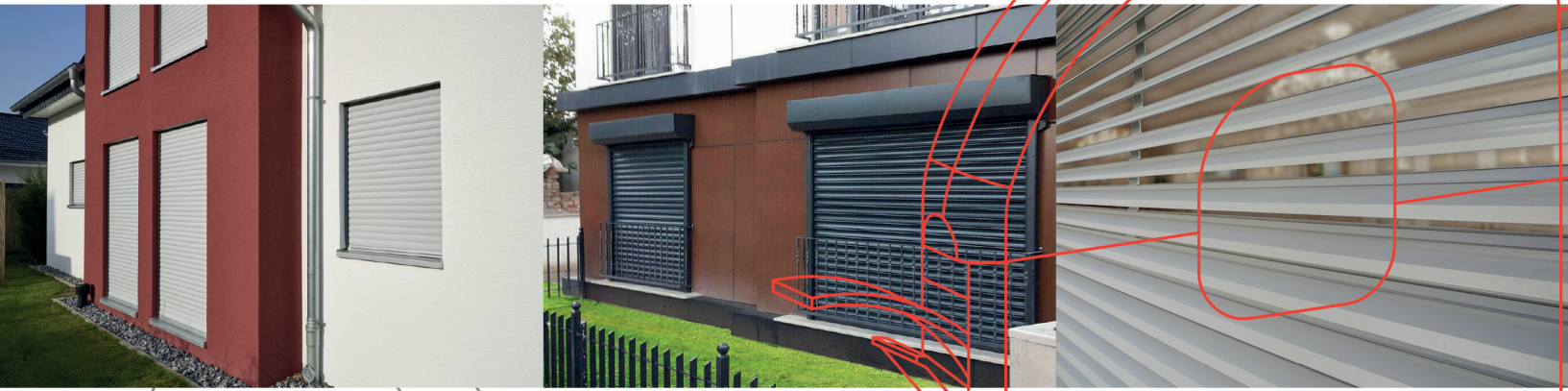

FİRMA PROFİLİ

BORAPANJUR, 1984 yılında panjur aksesuarları alanında üretime başlamıştır.

Kurulduğu andan itibaren yüksek kalitede ürün üretmek ve sınırsız müşteri memnuniyetini ilke edinen Borapanjur panjur sektörüne yeni ve yüksek kalitede ürün sağlamanın sonucu olarak lider bir firma haline gelmiştir. Günümüzde ise Borapanjur, İstanbul Arnavutköy'de 26.000 m²'lik modern tesislerde müşterilerine hizmet vermektedir.

Ayrıca firmamız, PVC pencere ve kapı sektörüne yönelik başarılı Ar-Ge çalışmalarının ardından GEVISS markası ile Çift Açılım Sistemleri, Tek Açılım Sistemleri ve Sürme Sistemleri üretimine 2006 yılında başlamıştır ve şu anda 50'yi aşkın ülkeye ihracat yapmaktadır.

Himsan Pencere ve Kapı Sistemleri A.Ş., siz değerli müşterilerimize verdikleri destekten dolayı teşekkür eder ve başarılı çalışmalarıyla dün, bugün olduğu gibi yarın da size hizmet etmekten gurur duyar.

COMPANY PROFILE









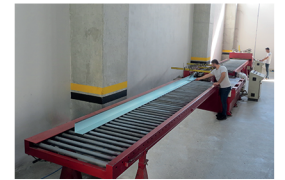
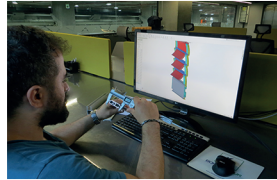
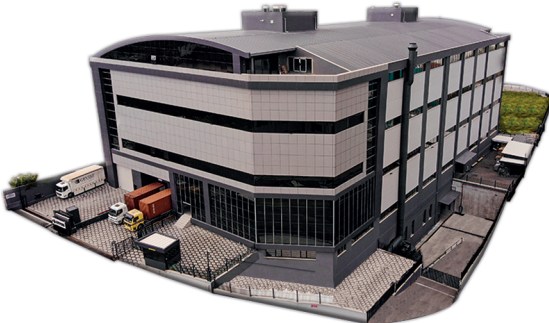















BORAPANJUR started production in the field of shutter accessories in 1984.

Having adopted the principle of producing high quality products and maximum customer satisfaction since its establishment, Borapanjur has become a leading company as a result of providing new and high quality products to the rolling shutter accessories sector. Today, Borapanjur serves its customers in its modern facilities of 26.000 m² in Arnavutköy, Istanbul.

In addition, our company started the production of Tilt and Turn Systems, Single Opening Systems and Sliding Systems under the brand of GEVISS in 2006, after successful R&D process for the PVC window and door sector, GEVISS currently exports its goods to more than 50 countries.

Himsan Window and Door Systems Inc. would like to thank you, our valued customers, for your support, and will be proud to serve you in the future, as it did yesterday, with its successful work.



	PANJUR SİSTEMLERİNE GENEL BAKIŞ GENERAL OVERVIEW FOR SHUTTER SYSTEMS	01 - 02
	ALÜMİNYUM DIŞTAN TAKMA PANJUR KUTULARI ALUMINIUM SHUTTER OUTWARD BOXES	03
	PANJUR YAN KAPAKLARI SHUTTER SIDE COVERS	03 - 04
	PANJUR LAMELLERİ [PROFİLLER] SHUTTER SLATS [PROFILES]	04 - 08
	PANJUR PROFİLLERİ SHUTTER PROFILES	09 - 11
	MAKASLI PANJUR PROFİLLERİ PROFILES FOR OUTWARD OPENING SCISSORED SHUTTERS	12
	SEKİZGEN VE YUVARLAK GALVANİZ BORULAR OCTAGONAL & ROUND GALVANIZED TUBES	13
	RULMANLAR BALL BEARINGS	14
	PLAKALI RULMAN VE MONTAJ SETLERİ BEARING SETS AND MONTAGE PLATES	15
	KASNAKLAR PULLEYS	16
	BORUBAŞLARI TUBE CAPS	17 - 18
	ÇELİK VE PLASTİK PANJUR ASKILARI STEEL AND PLASTIC SLAT HANGERS	19
	LAMEL [PROFİL] TAPALARI SLAT [PROFILE] CAPS	20
	ALÜMİNYUM PANJUR MAKAS VE MENTEŞELERİ SHUTTER SCISSORS AND HINGES	21
	OTOMATİK MAKARALAR AUTOMATIC STRAP BOXES	22 - 23
	SAC VE PLASTİK MAKARALAR METAL AND PLASTIC ROLLERS	23 - 24
	STOPERLER STOPPERS	25
	PANJUR KİLİTLERİ SHUTTER LOCKS	25
	PANJUR KORDONLARI SHUTTER STRAPS	26
	TÜP MOTORLAR TUBULAR MOTORS	27 - 28
	TÜP MOTOR AKSESUARLARI TUBULAR MOTOR ACCESSORIES	29 - 30
	AYARLANABİLİR JALUZI FONKSİYONLU PANJUR SİSTEMİ ADJUSTABLE BLADES ROLLING SHUTTER WITHOUT ROTATION MECHANISM	31 - 32
	155 - 185 MM MONOBLOK SİSTEM AKSESUARLARI 155 - 185 MM MONOBLOCK (PLASTIC) SYSTEMS ACCESSORIES	33 - 34
	MONOBLOK [PLASTİK] PANJUR SİSTEMLERİ MONOBLOCK [PLASTIC] SHUTTER SYSTEMS	35 - 38
	SİNEKLİK SİSTEMLERİ FLYING SCREENING SYSTEMS	39 - 40
	TEKNİK BİLGİLER TECHNICAL INFORMATIONS	41 - 42

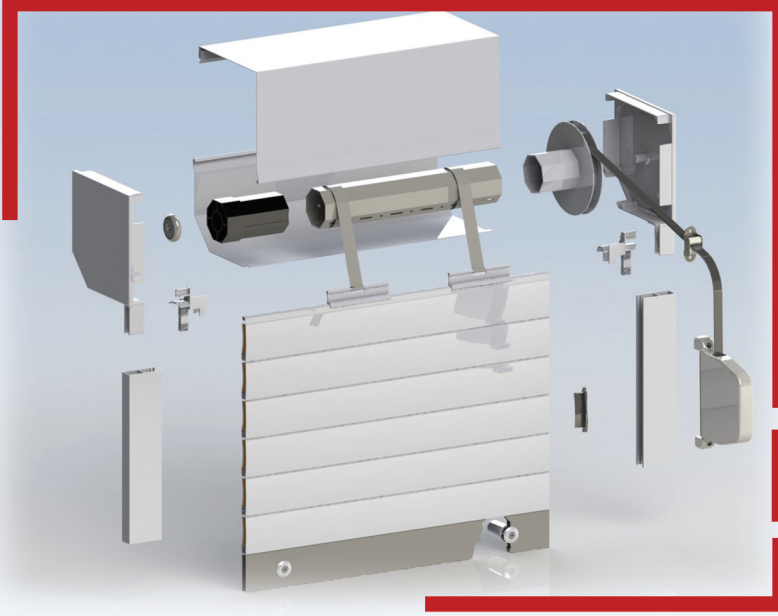

ALÜMİNYUM MAKARALI PANJUR SİSTEMİ
ALUMINIUM MANUAL SHUTTER SYSTEM

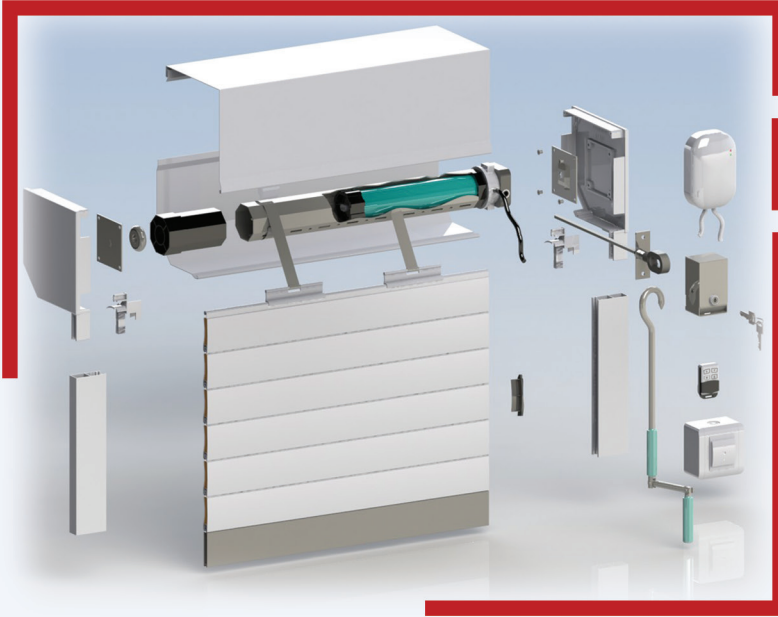

ALÜMİNYUM MOTORLU PANJUR VE KEPENK SİSTEMİ
ALUMINIUM MOTORIZED SHUTTER SYSTEM



DIŞA AÇILIM PANJUR SİSTEMİ
OUTWARD OPENING SHUTTER SYSTEM



MONOBLOK PANJUR SİSTEMİ
MONOBLOCK ROLLING SHUTTER SYSTEM

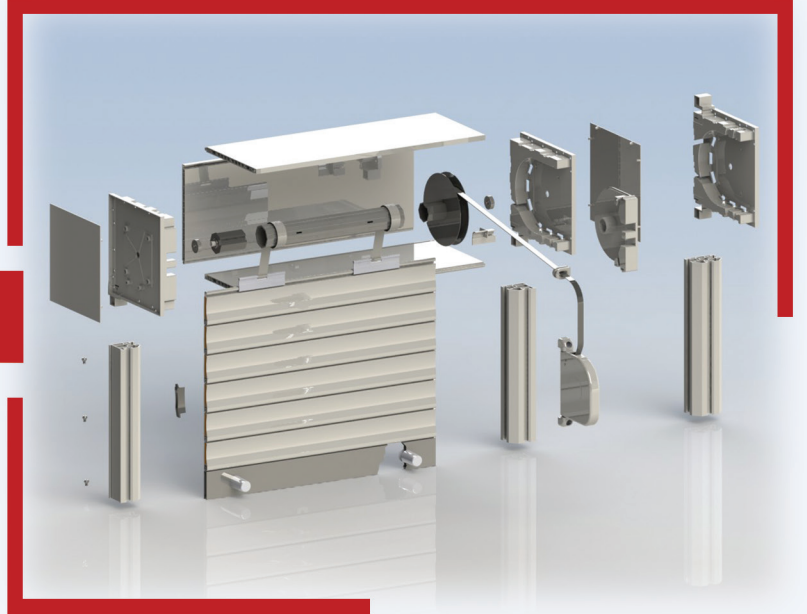

REDÜKTÖRLÜ PANJUR SİSTEMİ
ROLLING SHUTTER SYSTEM WITH HANDLE

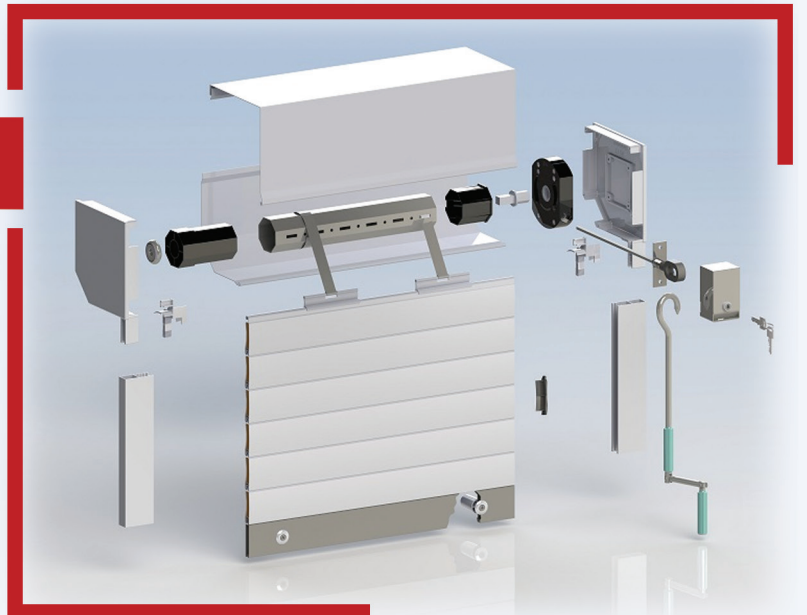



ALÜMİNYUM DIŞTAN TAKMA PANJUR KUTULARI - 45°

ALUMINIUM SHUTTER OUTWARD BOXES - 45°

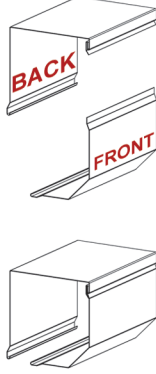

ALÜMİNYUM PANJUR KUTULARI - 45°

ALUMINIUM SHUTTER BOXES - 45°

ÜRÜN KODU PRODUCT CODE	AÇIKLAMA - EXPLANATION	PAKETLEME - PACKING
APK 137F.	ÖN KUTU / FRONT BOX 137 mm	5 PAKET - 5 PACK
APK 137B.	ARKA KUTU / BACK BOX 137 mm	5 PAKET - 5 PACK
APK 165F.	ÖN KUTU / FRONT BOX 165 mm	5 PAKET - 5 PACK
APK 165B.	ARKA KUTU / BACK BOX 165 mm	5 PAKET - 5 PACK
APK 205F.	ÖN KUTU / FRONT BOX 205 mm	3 PAKET - 3 PACK
APK 205B.	ARKA KUTU / BACK BOX 205 mm	3 PAKET - 3 PACK
APK 250F.	ÖN KUTU / FRONT BOX 250 mm	3 PAKET - 3 PACK
APK 250B.	ARKA KUTU / BACK BOX 250 mm	3 PAKET - 3 PACK
APK 300F.	ÖN KUTU / FRONT BOX 300 mm	3 PAKET - 3 PACK
APK 300B.	ARKA KUTU / BACK BOX 300 mm	3 PAKET - 3 PACK
APK 350F.	ÖN KUTU / FRONT BOX 350 mm	3 PAKET - 3 PACK
APK 350B.	ARKA KUTU / BACK BOX 350 mm	3 PAKET - 3 PACK

TEKNİK ÖZELLİKLERİ - TECHNICAL DETAILS

STANDART ÜRETİM UZUNLUĞU 6.00 MT

STANDART MANUFACTURING LENGTH 6.00 MT

RENK SEÇENEKLERİ - AVAILABLE COLORS

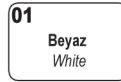

PANJUR YAN KAPAKLARI

SHUTTER SIDE COVERS

ALÜMİNYUM DÖKÜM YAN KAPAK 45°

ALUMINIUM DIE CASTING SIDE CAP 45°

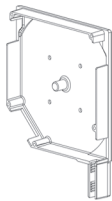
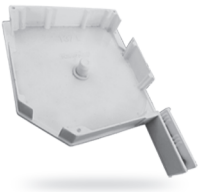

ÜRÜN KODU PRODUCT CODE	AÇIKLAMA - EXPLANATION	PAKETLEME - PACKING
YKP DS137.	137 MM PİMLİ / 137 MM WITH PIVOT	30 TAKIM - 30 SET
YKP DS165.	165 MM PİMLİ / 165 MM WITH PIVOT	30 TAKIM - 30 SET
YKP DS205.	205 MM PİMLİ / 205 MM WITH PIVOT	30 TAKIM - 30 SET

RENK SEÇENEKLERİ - AVAILABLE COLORS





PANJUR YAN KAPAKLARI SHUTTER SIDE COVERS

GALVANİZ YAN KAPAK GALVANIZED SIDE CAP

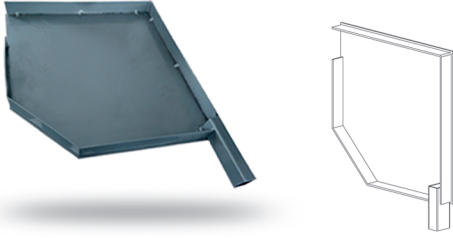

ÜRÜN KODU PRODUCT CODE	AÇIKLAMA - EXPLANATION	PAKETLEME - PACKING
YKP GS250.	250 MM	5 TAKIM - 5 SET
YKP GS300.	300 MM	5 TAKIM - 5 SET
YKP GS350.	350 MM	5 TAKIM - 5 SET
YKP GS400.	400 MM	5 TAKIM - 5 SET

RENK SEÇENEKLERİ - AVAILABLE COLORS

01 Beyaz White	02 Metalik Gri Metallic Grey	22 Antrasit Gri Antrachite Grey	13 Altın Meşe Golden Oak	03 Koyu Kahve Dark Brown	
-----------------------------	---	--	---------------------------------------	---------------------------------------	--

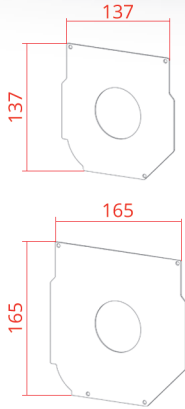

YAN KAPAK İÇİ PLASTİK MUHAFAZA INNER PROTECTIVE PART FOR SIDE CAP

YKP MUH137

137 MM YAN KAPAK İÇİ PLASTİK MUHAFAZA
137 MM INNER PROTECTIVE PART FOR SIDE CAP

YKP MUH165

165 MM YAN KAPAK İÇİ PLASTİK MUHAFAZA
165 MM INNER PROTECTIVE PART FOR SIDE CAP



PANJUR LAMELLERİ [PROFİLLER] SHUTTER SLATS [PROFILES]

39 MM ALÜMİNYUM POLİÜRETAN DOLGULU LAMELLER 39 MM ALUMINIUM POLYURETHANE FILLED SLATS

PLM POL39.

TEKNİK ÖZELLİKLERİ - TECHNICAL DETAILS

Bir lineer metrenin ağırlığı (kg) One linear meter weight (kg)	0,100
Bir metrekarenin ağırlığı (kg) One squaremeter weight (kg)	2,564
Bir metre yükseklikteki lamel sayısı Slat quantity in one meter height	25,64
Tavsiye edilen azami genişlik x yükseklik Suggested max. dimension width x height	2,600 x 2,600

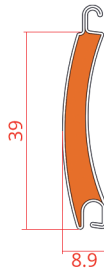

RENK SEÇENEKLERİ - AVAILABLE COLORS

01 Beyaz White	02 Metalik Gri Metallic Grey	22 Antrasit Gri Antrachite Grey	03 Koyu Kahve Dark Brown	GO Altın Meşe Golden Oak	
-----------------------------	---	--	---------------------------------------	---------------------------------------	--



55 MM ALÜMİNYUM POLİÜRETAN DOLGULU LAMELLER 55 MM ALUMINIUM POLYURETHANE FILLED SLATS

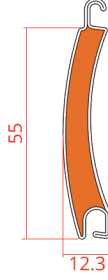

PLM POL55.

TEKNİK ÖZELLİKLERİ - TECHNICAL DETAILS

Bir lineer metrenin ağırlığı (kg) <i>One linear meter weight (kg)</i>	0,198
Bir metrekarenin ağırlığı (kg) <i>One squaremeter weight (kg)</i>	3,600
Bir metre yükseklikteki lamel sayısı <i>Slat quantity in one meter height</i>	18,18
Tavsiye edilen azami genişlik x yükseklik <i>Suggested max. dimension width x height</i>	3,500 x 3,000

RENK SEÇENEKLERİ - AVAILABLE COLORS



77 MM ALÜMİNYUM POLİÜRETAN DOLGULU LAMELLER 77 MM ALUMINIUM POLYURETHANE FILLED SLATS

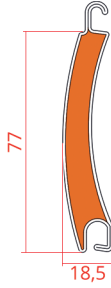

PLM POL77.

TEKNİK ÖZELLİKLERİ - TECHNICAL DETAILS

Bir lineer metrenin ağırlığı (kg) <i>One linear meter weight (kg)</i>	0,355
Bir metrekarenin ağırlığı (kg) <i>One squaremeter weight (kg)</i>	4,611
Bir metre yükseklikteki lamel sayısı <i>Slat quantity in one meter height</i>	12,99
Tavsiye edilen azami genişlik x yükseklik <i>Suggested max. dimension width x height</i>	5,000 x 3,000

RENK SEÇENEKLERİ - AVAILABLE COLORS



77 MM GALVANİZ (SAC) POLİÜRETAN DOLGULU LAMELLER 77 MM GALVANISED POLYURETHANE FILLED SLATS

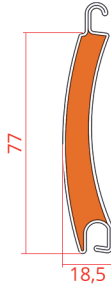

PLM GLV77.

TEKNİK ÖZELLİKLERİ - TECHNICAL DETAILS

Bir lineer metrenin ağırlığı (kg) <i>One linear meter weight (kg)</i>	0,98
Bir metrekarenin ağırlığı (kg) <i>One squaremeter weight (kg)</i>	12,8
Bir metre yükseklikteki lamel sayısı <i>Slat quantity in one meter height</i>	12,99
Tavsiye edilen azami genişlik x yükseklik <i>Suggested max. dimension width x height</i>	5,000 x 3,000

RENK SEÇENEKLERİ - AVAILABLE COLORS





95 MM GALVANİZ (SAC) POLİÜRETAN DOLGULU LAMELLER 95 MM GALVANISED POLYURETHANE FILLED SLATS

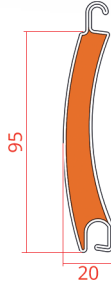
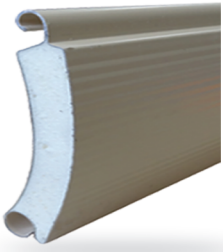

PLM GLV95.

TEKNİK ÖZELLİKLERİ - TECHNICAL DETAILS

Bir lineer metrenin ağırlığı (kg) One linear meter weight (kg)	1,15
Bir metrekarenin ağırlığı (kg) One squaremeter weight (kg)	12,10
Bir metre yükseklikteki lamel sayısı Slat quantity in one meter height	10,526
Tavsiye edilen azami genişlik x yükseklik Suggested max. dimension width x height	6,000 x 4,000

RENK SEÇENEKLERİ - AVAILABLE COLORS



44 MM EXTRÜZE PANJUR LAMELLERİ 44 MM EXTRUDED SHUTTER SLATS

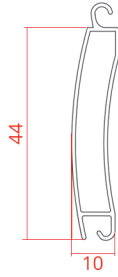

PLM EXT44.

TEKNİK ÖZELLİKLERİ - TECHNICAL DETAILS

Bir lineer metrenin ağırlığı (kg) One linear meter weight (kg)	0,35
Bir metrekarenin ağırlığı (kg) One squaremeter weight (kg)	7,95
Bir metre yükseklikteki lamel sayısı Slat quantity in one meter height	22,73
Tavsiye edilen azami genişlik x yükseklik Suggested max. dimension width x height	3,000 x 2,800

56 MM EXTRÜZE PANJUR LAMELLERİ 56 MM EXTRUDED SHUTTER SLATS

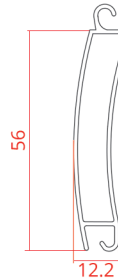

PLM EXT56.

TEKNİK ÖZELLİKLERİ - TECHNICAL DETAILS

Bir lineer metrenin ağırlığı (kg) One linear meter weight (kg)	0,48
Bir metrekarenin ağırlığı (kg) One squaremeter weight (kg)	8,5
Bir metre yükseklikteki lamel sayısı Slat quantity in one meter height	17,85
Tavsiye edilen azami genişlik x yükseklik Suggested max. dimension width x height	4,600x 3,000

RENK SEÇENEKLERİ - AVAILABLE COLORS





PANJUR LAMELLERİ [PROFİLLER]

SHUTTER SLATS [PROFILES]

62 MM EXTRÜZE PANJUR LAMELLERİ 62 MM EXTRUDED SHUTTER SLATS

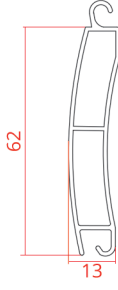

PLM EXT62.

TEKNİK ÖZELLİKLERİ - TECHNICAL DETAILS

Bir lineer metrenin ağırlığı (kg) One linear meter weight (kg)	0,516
Bir metre karenin ağırlığı (kg) One squaremeter weight (kg)	8,27
Bir metre yükseklikteki lamel sayısı Slat quantity in one meter height	16
Tavsiye edilen azami genişlik x yükseklik Suggested max. dimension width x height	5,000 x 3,000

77 MM EXTRÜZE PANJUR LAMELLERİ 77 MM EXTRUDED SHUTTER SLATS

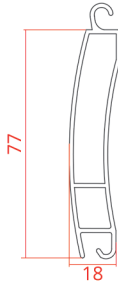

PLM EXT77.

TEKNİK ÖZELLİKLERİ - TECHNICAL DETAILS

Bir lineer metrenin ağırlığı (kg) One linear meter weight (kg)	0,56
Bir metre karenin ağırlığı (kg) One squaremeter weight (kg)	7,27
Bir metre yükseklikteki lamel sayısı Slat quantity in one meter height	12,99
Tavsiye edilen azami genişlik x yükseklik Suggested max. dimension width x height	5,500 x 3,500

RENK SEÇENEKLERİ - AVAILABLE COLORS



62 MM GÖZLÜ EXTRÜZE PANJUR LAMELLERİ 62 MM EXTRUDED HOLLOWED SHUTTER SLATS

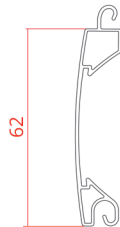
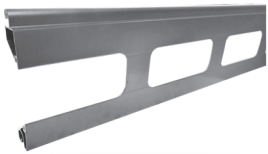

PLM EXTG62.

TEKNİK ÖZELLİKLERİ - TECHNICAL DETAILS

Bir lineer metrenin ağırlığı (kg) One linear meter weight (kg)	0,44
Bir metre karenin ağırlığı (kg) One squaremeter weight (kg)	7,10
Bir metre yükseklikteki lamel sayısı Slat quantity in one meter height	16,12
Tavsiye edilen azami genişlik x yükseklik Suggested max. dimension width x height	5,000 x 3,000

RENK SEÇENEKLERİ - AVAILABLE COLORS

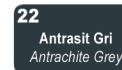



PANJUR LAMELLERİ [PROFİLLER]

SHUTTER SLATS [PROFILES]

77 MM GÖZLÜ EXTRÜZE PANJUR LAMELLERİ 77 MM EXTRUDED HOLLOWED SHUTTER SLATS

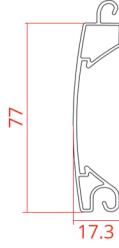
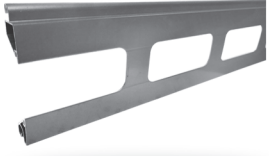

PLM EXTG77.

TEKNİK ÖZELLİKLERİ - TECHNICAL DETAILS

Bir lineer metrenin ağırlığı (kg) <i>One linear meter weight (kg)</i>	0,865
Bir metre karenin ağırlığı (kg) <i>One squaremeter weight (kg)</i>	11,23
Bir metre yükseklikteki lamel sayısı <i>Slat quantity in one meter height</i>	12,98
Tavsiye edilen azami genişlik x yükseklik <i>Suggested max. dimension width x height</i>	5,500 x 3,500

RENK SEÇENEKLERİ - AVAILABLE COLORS



50 MM KURŞUN GEÇİRMEZ LAMEL (EKSTRÜZE) 50 MM BULLET PROOF SLAT (EXTRUDED)

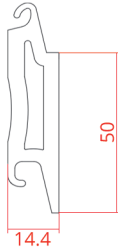

PLM BLP50.

TEKNİK ÖZELLİKLERİ - TECHNICAL DETAILS

Bir lineer metrenin ağırlığı (kg) <i>One linear meter weight (kg)</i>	1,375
Bir metre karenin ağırlığı (kg) <i>One squaremeter weight (kg)</i>	27,5
Bir metre yükseklikteki lamel sayısı <i>Slat quantity in one meter height</i>	20
Tavsiye edilen azami genişlik x yükseklik <i>Suggested max. dimension width x height</i>	7,000 x 5,000

RENK SEÇENEKLERİ - AVAILABLE COLORS



PLASTİK (PVC) PANJUR LAMELLERİ PLASTIC (PVC) SHUTTER SLATS

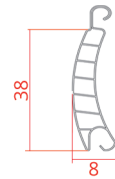

PLM PLS38.01 38 mm Çizgisiz
38 mm Unlined

PLM PLS38.01C 38 mm Çizgili
38 mm Lined

PLM PLS55.01 55 mm Çizgili
55 mm Lined

TEKNİK ÖZELLİKLERİ - TECHNICAL DETAILS

Bir lineer metrenin ağırlığı (kg) <i>One linear meter weight (kg)</i>	0,355
Bir metre karenin ağırlığı (kg) <i>One squaremeter weight (kg)</i>	4,611
Bir metre yükseklikteki lamel sayısı <i>Slat quantity in one meter height</i>	12,99
Tavsiye edilen azami genişlik x yükseklik <i>Suggested max. dimension width x height</i>	5,000 x 3,000

RENK SEÇENEKLERİ - AVAILABLE COLORS





YAN DİKME PROFİLİ - 39 MM
SIDE COLUMN PROFILE - 39 MM

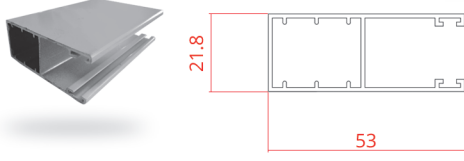

PRF Y39.

PAKETLEME - PACKING

PAKET 6 BOY
PACK 6 PCS.

TEKNİK ÖZELLİKLERİ - TECHNICAL DETAILS

STANDART ÜRETİM UZUNLUĞU 6.00 MT
STANDART MANUFACTURING LENGTH 6.00 MT

YAN DİKME PROFİLİ - 55 MM
SIDE COLUMN PROFILE - 55MM

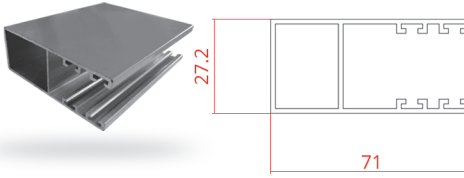

PRF Y55.

PAKETLEME - PACKING

PAKET 5 BOY
PACK 5 PCS.

TEKNİK ÖZELLİKLERİ - TECHNICAL DETAILS

STANDART ÜRETİM UZUNLUĞU 6.00 MT
STANDART MANUFACTURING LENGTH 6.00 MT

YAN DİKME PROFİLİ - 77 MM
SIDE COLUMN PROFILE - 77 MM

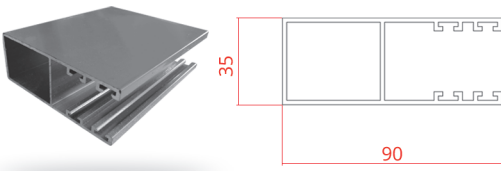

PRF Y77.

PAKETLEME - PACKING

PAKET 4 BOY
PACK 4 PCS.

TEKNİK ÖZELLİKLERİ - TECHNICAL DETAILS

STANDART ÜRETİM UZUNLUĞU 6.00 MT
STANDART MANUFACTURING LENGTH 6.00 MT

YAN DİKME PROFİLİ - 95 MM
SIDE COLUMN PROFILE - 95 MM

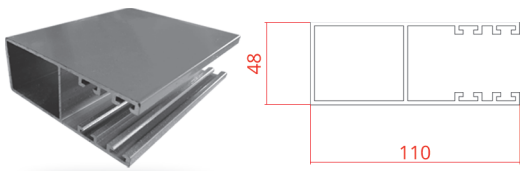

PRF Y95.

PAKETLEME - PACKING

PAKET 3 BOY
PACK 3 PCS.

TEKNİK ÖZELLİKLERİ - TECHNICAL DETAILS

STANDART ÜRETİM UZUNLUĞU 6.00 MT
STANDART MANUFACTURING LENGTH 6.00 MT

YAN DİKME PROFİLİ / KURŞUN GEÇİRMEZ İÇİN - 90 MM
SIDE COLUMN PROFILE / FOR BULLET PROOF SYSTEMS - 90 MM

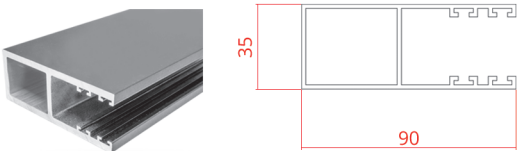

PRF BLP90.

TEKNİK ÖZELLİKLERİ - TECHNICAL DETAILS

STANDART ÜRETİM UZUNLUĞU 6.00 MT
STANDART MANUFACTURING LENGTH 6.00 MT

RENK SEÇENEKLERİ - AVAILABLE COLORS





ORTA DİKME PROFİLİ - 39 MM MIDDLE COLUMN PROFILE - 39 MM

PRF M39.

TEKNİK ÖZELLİKLERİ - TECHNICAL DETAILS

STANDART ÜRETİM UZUNLUĞU 6.00 MT
STANDART MANUFACTURING LENGTH 6.00 MT

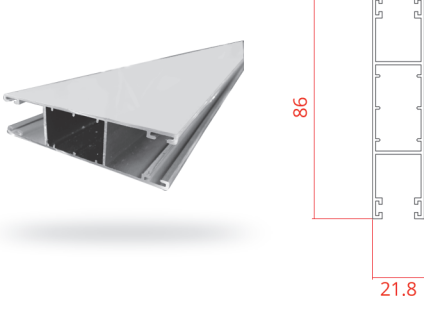

RENK SEÇENEKLERİ - AVAILABLE COLORS

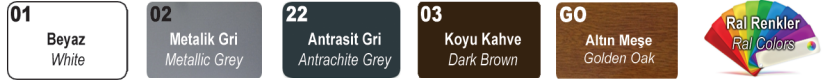

ORTA DİKME PROFİLİ - 55 MM MIDDLE COLUMN PROFILE - 55 MM

PRF M55.

TEKNİK ÖZELLİKLERİ - TECHNICAL DETAILS

STANDART ÜRETİM UZUNLUĞU 6.00 MT
STANDART MANUFACTURING LENGTH 6.00 MT

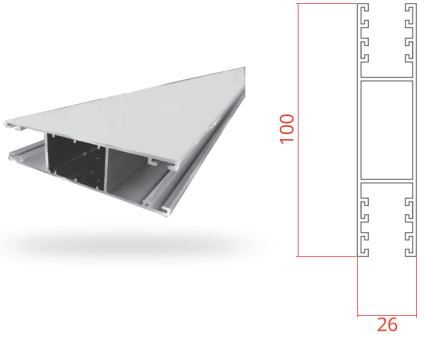

RENK SEÇENEKLERİ - AVAILABLE COLORS



ALT PARÇA PROFİLİ - 50 MM KURŞUN GEÇİRMEZ EN SLAT PROFILE - 50 MM BULLET PROOF

PRF BLP50.

TEKNİK ÖZELLİKLERİ - TECHNICAL DETAILS

STANDART ÜRETİM UZUNLUĞU 6.00 MT
STANDART MANUFACTURING LENGTH 6.00 MT



RENK SEÇENEKLERİ - AVAILABLE COLORS





ALT PARÇA PROFİLİ - 39 MM
END SLAT PROFILE - 39 MM



PRF A39.

TEKNİK ÖZELLİKLERİ - TECHNICAL DETAILS

STANDART ÜRETİM UZUNLUĞU 6.00 MT
STANDART MANUFACTURING LENGTH 6.00 MT

PAKETLEME - PACKING

PAKET 10 BOY
PACK 10 PCS.

ALT PARÇA PROFİLİ - 55 MM
END SLAT PROFILE - 55 MM

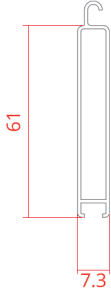

PRF A55.

TEKNİK ÖZELLİKLERİ - TECHNICAL DETAILS

STANDART ÜRETİM UZUNLUĞU 6.00 MT
STANDART MANUFACTURING LENGTH 6.00 MT

PAKETLEME - PACKING

PAKET 8 BOY
PACK 8 PCS.

ALT PARÇA PROFİLİ - 77 MM
END SLAT PROFILE - 77 MM



PRF A77.

TEKNİK ÖZELLİKLERİ - TECHNICAL DETAILS

STANDART ÜRETİM UZUNLUĞU 6.00 MT
STANDART MANUFACTURING LENGTH 6.00 MT

PAKETLEME - PACKING

PAKET 6 BOY
PACK 6 PCS.

ALT PARÇA PROFİLİ - 95 MM
END SLAT PROFILE - 95 MM



PRF A95.

TEKNİK ÖZELLİKLERİ - TECHNICAL DETAILS

STANDART ÜRETİM UZUNLUĞU 6.00 MT
STANDART MANUFACTURING LENGTH 6.00 MT

PAKETLEME - PACKING

PAKET 3 BOY
PACK 3 PCS.

RENK SEÇENEKLERİ - AVAILABLE COLORS

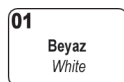



MAKASLI PANJUR PROFİLLERİ

PROFILES FOR OUTWARD OPENING SCISSORED SHUTTERS

ALÜMİNYUM KUTU PROFİL ALUMINIUM BOX PROFILE

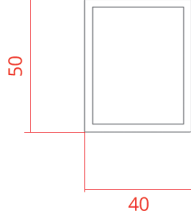
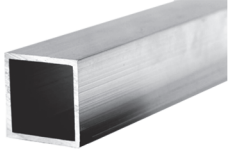

PRF MKS01.

TEKNİK ÖZELLİKLERİ - TECHNICAL DETAILS

STANDART ÜRETİM UZUNLUĞU 6.00 MT
STANDART MANUFACTURING LENGTH 6.00 MT

RENK SEÇENEKLERİ - AVAILABLE COLORS

01

Beyaz
White

02

Metalik Gri
Metallic Grey

22

Antrasit Gri
Antrachite Grey

13

Altın Meşe
Golden Oak

03

Koyu Kahve
Dark Brown



FİTİLLİ "U"

"U" PROFILE WITH BRUSH GUIDE CHANNEL

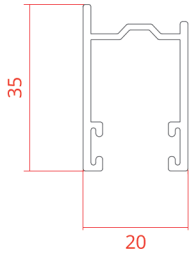
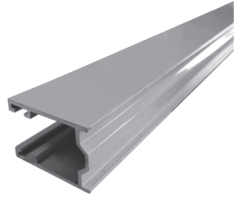

PRF MKS02.

TEKNİK ÖZELLİKLERİ - TECHNICAL DETAILS

STANDART ÜRETİM UZUNLUĞU 6.00 MT
STANDART MANUFACTURING LENGTH 6.00 MT

RENK SEÇENEKLERİ - AVAILABLE COLORS

01

Beyaz
White

02

Metalik Gri
Metallic Grey

22

Antrasit Gri
Antrachite Grey

13

Altın Meşe
Golden Oak

03

Koyu Kahve
Dark Brown



DAR "L" PROFİLİ

NARROW "L" PROFILE

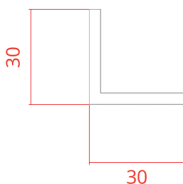
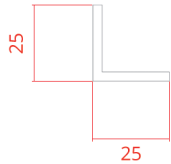

PRF MKS03.

39 MM LAMELE GÖRE
FOR 39 MM SLATS

PRF MKS04.

55 MM LAMELE GÖRE
FOR 55 MM SLATS

RENK SEÇENEKLERİ - AVAILABLE COLORS

01

Beyaz
White

02

Metalik Gri
Metallic Grey

22

Antrasit Gri
Antrachite Grey

13

Altın Meşe
Golden Oak

03

Koyu Kahve
Dark Brown





SEKİZGEN VE YUVARLAK GALVANİZ BORULAR

OCTAGONAL & ROUND GALVANIZED TUBES

SEKİZGEN GALVANİZ BORU - Ø 40 MM

OCTAGONAL GALVANIZED TUBE DIA. 40 MM Ø

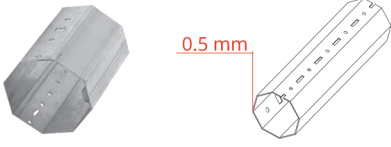

BOR G40.50

0.50 MM KALINLIK
0.50 MM THICKNESS

PAKETLEME - PACKING

PAKET 10 BOY
PACK 10 PCS.

SEKİZGEN GALVANİZ BORU - Ø 60 MM

OCTAGONAL GALVANIZED TUBE DIA. 60 MM Ø

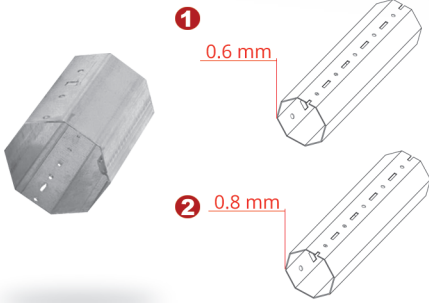

1 BOR G60.60

0.60 MM KALINLIK
0.60 MM THICKNESS

2 BOR G60.80

0.80 MM KALINLIK
0.80 MM THICKNESS

PAKETLEME - PACKING

PAKET 6 BOY
PACK 6 PCS.

SEKİZGEN GALVANİZ BORU - Ø 70 MM

OCTAGONAL GALVANIZED TUBE DIA. 70 MM Ø

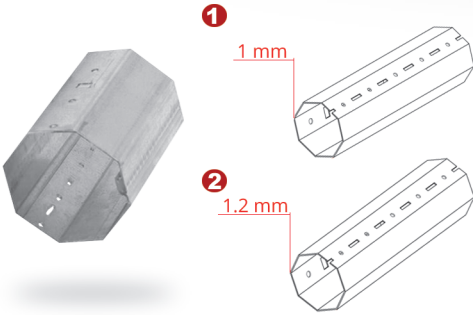

1 BOR G70.100

1.00 MM KALINLIK
1.00 MM THICKNESS

2 BOR G70.120

1.20 MM KALINLIK
1.20 MM THICKNESS

PAKETLEME - PACKING

PAKET 3 BOY
PACK 3 PCS.

YUVARLAK GALVANİZ BORULAR - Ø 102 MM

ROUND GALVANIZED TUBES - Ø 102 MM

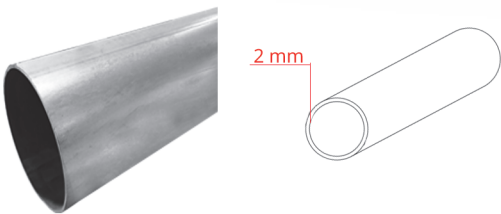

BOR G102.200

102 MM / 2.00 MM KALINLIK
102 MM / 2.00 MM THICKNESS

PAKETLEME - PACKING

PAKET 1 BOY
PACK 1 PCS.

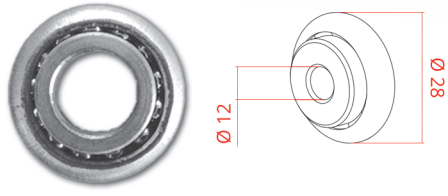

28 MM RULMAN - 12 MM DELİK ÇAPI
28 MM BALL BEARING - HOLE DIA. 12 MM

RLM 28.12

PAKETLEME - PACKING

PAKET 100 ADET / KOLİ 1000 ADET
PACK 100 PCS. / BOX 1000 PCS..

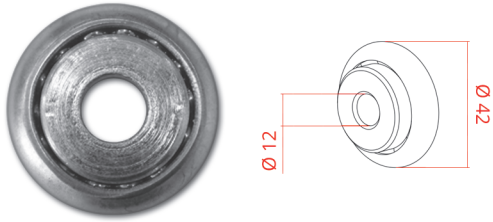

42 MM RULMAN
42 MM BALL BEARING

RLM 42.12

12 MM İÇ ÇAP
12 MM INNER DIA

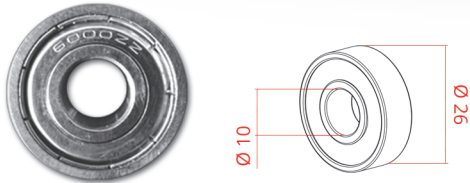

MONOBLOK İÇİN 6000 ZZ RULMAN
6000 ZZ BALL BEARING FOR MONOBLOCKS

RLM 28.10ZZ

10 MM DELİK ÇAPI
HOLE DIA 10 MM

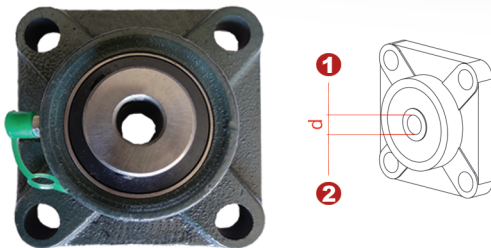

PLAKALI (YASTIK TİPİ) RULMAN
BALL BEARING WITH PLATE (PILLOW TYPE)

1 RLM PLK.D12 d=12 MM D= 60 & 70

2 RLM PLK.D20 d=20 MM D= 102



AY (NAL) KASETLER MOON (HORSESHOE) CASSETTES



RLM AY.28 28 MM

RULMAN YUVALI PLAKALAR PLATES WITH BALL BEARING HOLE

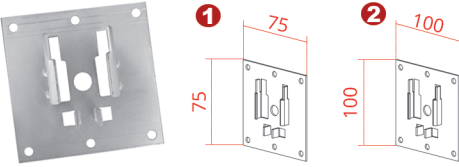

1 PLT RLM.75X 75 * 75 RULMAN PLAKASI
75 * 75 BEARING PLATE

2 PLT RLM.100X 100 * 100 RULMAN PLAKASI
100 * 100 BEARING PLATE

MOTOR MONTAJ PLAKALARI TUBULAR MOTOR FIXING PLATES

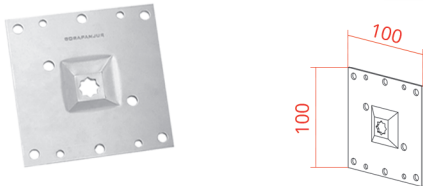

PLT M.100 100 * 100 PLAKA
100 * 100 PLATE



1

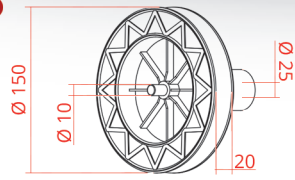

PLASTİK KASNAKLAR - YUVARLAK BORU İÇİN
PLASTIC PULLEYS - FOR ROUND TUBE

1 **KAS Y.25** 25 MM

2 **KAS Y.38** 38 MM

PAKETLEME - PACKING

PAKET 100 ADET
PACK 100 PCS.



2

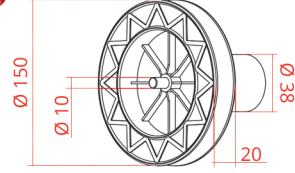

SEKİZGEN PLASTİK KASNAKLAR - PİMLİ
OCTAGONAL PLASTIC PULLEYS - WITH PIVOT

1 **KAS S14.12P** 14 MM / 12 MM PİM
14 MM / 12 MM PIVOT

2 **KAS S14.10P** 14 MM / 10 MM PİM
14 MM / 10 MM PIVOT

3 **KAS S22.12P** 22 MM / 12 MM PİM
22 MM / 12 MM PIVOT

4 **KAS S22.10P** 22 MM / 10 MM PİM
22 MM / 10 MM PIVOT

PAKETLEME - PACKING

PAKET 100 ADET
PACK 100 PCS.

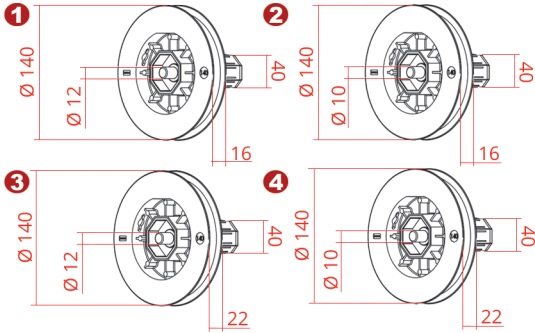

SEKİZGEN PLASTİK KASNAKLAR - RULMAN YUVALI
OCTAGONAL PLASTIC PULLEYS - WITH BEARING HOLE

1 **KAS R.115** 115 MM

2 **KAS R.140** 140 MM

PAKETLEME - PACKING

1 PAKET 150 ADET
PACK 150 PCS.

2 PAKET 100 ADET
PACK 100 PCS.

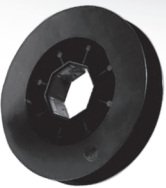
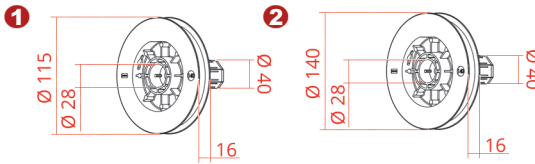

SEKİZGEN İÇİ BOŞ PLASTİK KASNAK
OCTAGONAL PLASTIC HOLLOW PULLEY

1 **KAS B.15** 15 MM

2 **KAS B.22** 22 MM

PAKETLEME - PACKING

PAKET 100 ADET
PACK 100 PCS.

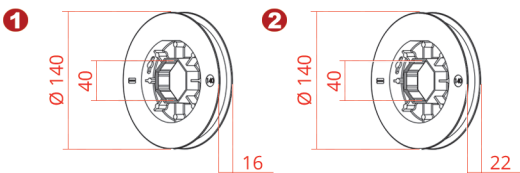



BORU BAŞLARI TUBE CAPS

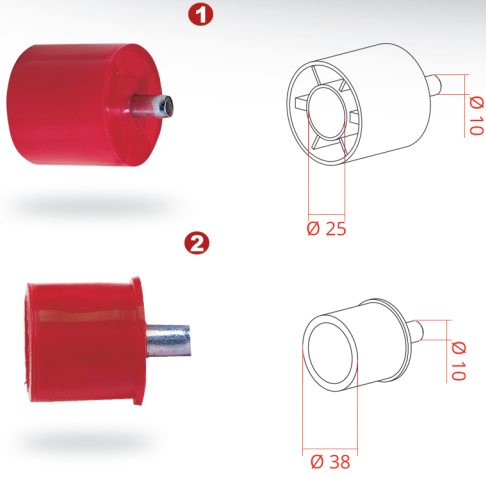

PLASTİK BORUBAŞI - YUVARLAK BORU İÇİN PLASTIC TUBE CAPS - FOR ROUND TUBE

- 1 **BRB Y.25** 25 MM
- 2 **BRB Y.38** 38 MM

PAKETLEME - PACKING
PAKET 100 ADET
PACK 100 PCS.

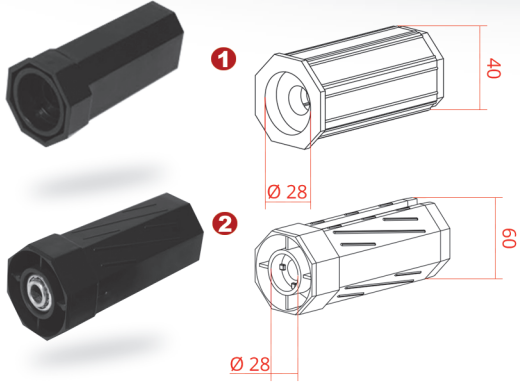

SEKİZGEN PLASTİK BORUBAŞLARI - RULMAN YUVALI OCTAGONAL PLASTIC TUBE CAPS - WITH BALL BEARING HOLE

- 1 **BRB R40.28** 40 MM BORU İÇİN
40 MM TUBE
- 2 **BRB R60.28** 60 MM BORU İÇİN
60 MM TUBE

PAKETLEME - PACKING
PAKET 100 ADET
PACK 100 PCS.

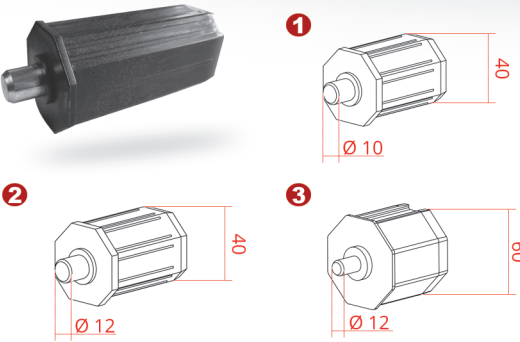

SEKİZGEN PLASTİK BORUBAŞLARI - PİMLİ OCTAGONAL PLASTIC TUBE CAPS - WITH PIVOT

- 1 **BRB S40.10P** 40 MM / 10 MM PİMLİ
40 MM / 10 MM PIVOT
- 2 **BRB S40.12P** 40 MM / 12 MM PİMLİ
40 MM / 12 MM PIVOT
- 3 **BRB S60.12P** 60 MM / 12 MM PİMLİ
60 MM / 12 MM PIVOT

PAKETLEME - PACKING
1 PAKET 200 ADET
PACK 200 PCS.
2 PAKET 200 ADET
PACK 200 PCS.
3 PAKET 100 ADET
PACK 100 PCS.

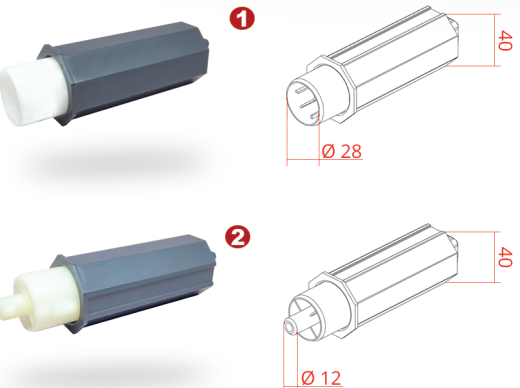

SEKİZGEN PLASTİK BORU BAŞLARI - 40 MM OCTAGONAL PLASTIC TUBE CAPS - 40 MM

- 1 **BRB TR40.28** TELESKOPIK 28/12 MM RULMAN YUVALI
TELESCOPIC 28/12 MM WITH BALL BEARING HOLE
- 2 **BRB TP40.12** TELESKOPIK 12 MM PİMLİ
TELESCOPIC 12 MM PIVOT



BORU BAŞLARI TUBE CAPS



1

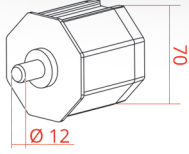

SEKİZGEN BORU BAŞLARI - 70 MM OCTAGONAL TUBE CAPS - 70 MM

1 **BRB P70.12**

PLASTİK / 12 MM PİMLİ
PLASTIC / 12 MM PIVOT

2 **BRB A70.12**

ALÜMİNYUM / 12 MM PİMLİ
ALUMINIUM / 12 MM PIVOT

PAKETLEME - PACKING

1 PAKET 150 ADET
PACK 150 PCS.

2 PAKET 40 ADET
PACK 40 PCS.



2

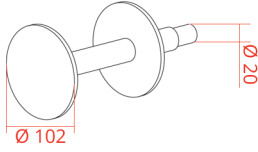
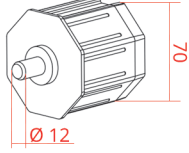

YUVARLAK BORUBAŞI ROUND TUBE CAPS

BRB A102.200

102 MM BORU İÇİN
102 MM TUBE

TEKNİK ÖZELLİKLERİ - TECHNICAL DETAILS

AYARLANABİLİR
ADJUSTABLE

PLASTİK ARA TAKOZU - 25 MM BORU İÇİN PLASTIC BREAK CHOCK - FOR 25 MM TUBE

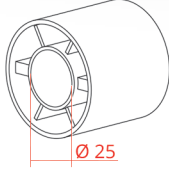

BRB AT.25

PAKETLEME - PACKING

PAKET 100 ADET
PACK 100 PCS.

GEÇİŞ ADAPTÖRÜ 40 MM -> 60 MM ADAPTOR FOR TUBE FROM 40 MM -> 60 MM

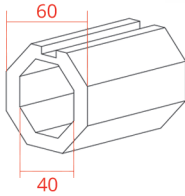
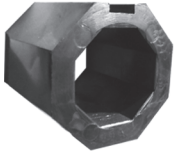

BRB GA.4060

40 MM -> 60 MM
40 MM -> 60 MM

PAKETLEME - PACKING

PAKET 100 ADET
PACK 100 PCS.

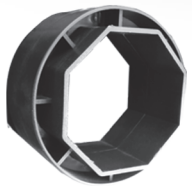

1

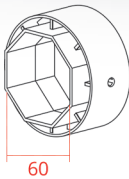

PLASTİK BORU BİLEZİKLERİ PLASTIC TUBE CIRCLES

1 **BRB BL.60**

BİLEZİK - 60 MM BORU İÇİN
CIRCLE - FOR 60 MM TUBE

2 **BRB BL.70**

BİLEZİK - 70 MM BORU İÇİN
CIRCLE - FOR 70 MM TUBE

PAKETLEME - PACKING

PAKET 100 ADET
PACK 100 PCS.

2

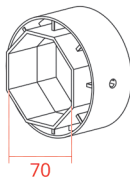



ÇELİK VE PLASTİK PANJUR ASKILARI STEEL AND PLASTIC SLAT HANGERS

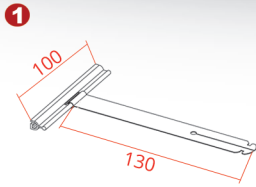

ÇELİK PANJUR ASKISI - 130 MM STEEL SLAT HANGER - 130 MM

1 **PAS 130.G**

GEÇMELİ
BY INSERTING

2 **PAS 130.V**

VİDALI
BY SCREWING

PAKETLEME - PACKING

PAKET 100 ADET / KOLİ 1000 ADET
PACK 100 PCS. / BOX 1000 PCS.

TEKNİK ÖZELLİKLERİ - TECHNICAL DETAILS

ÇELİK YAY
STEEL SPRING

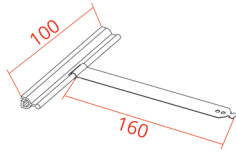
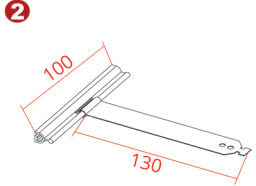

ÇELİK PANJUR ASKISI - 160 MM STEEL SLAT HANGER - 160 MM

PAS 160.V

VİDALI
BY SCREWING

PAKETLEME - PACKING

PAKET 50 ADET
PACK 50 PCS.

TEKNİK ÖZELLİKLERİ - TECHNICAL DETAILS

ÇELİK YAY
STEEL SPRING

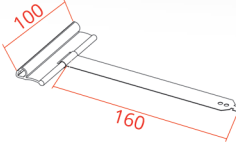

ÇELİK PANJUR ASKISI (EKSTRÜZE LAMEL İÇİN) - 160 MM STEEL SLAT HANGER (FOR EXTRUDED SLATS) - 160 MM

PAS 160.E

VİDALI
BY SCREWING

PAKETLEME - PACKING

PAKET 50 ADET
PACK 50 PCS.

TEKNİK ÖZELLİKLERİ - TECHNICAL DETAILS

ÇELİK YAY
STEEL SPRING



KEPENK (GÜVENLİKLİ) KİLİT ASKILARI LOCKED HOOK SYSTEM FOR ROLLING DOORS

1 **KLT 40.39**

40 MM BORU İÇİN/ 39 MM LAMELE GÖRE
39 MM SLAT SUIT / FOR 40 MM TUBE

PAKETLEME - PACKING

PAKET 25 ADET
PACK 25 PCS.

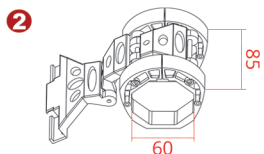
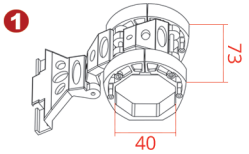

2 **KLT 60.39**

60 MM BORU İÇİN/ 39 MM LAMELE GÖRE
39 MM SLAT SUIT / FOR 60 MM TUBE

3 **KLT 60.77**

60 MM BORU İÇİN/ 55,62,77MM LAMELE GÖRE
55,62,77 MM SLAT SUIT / FOR 60 MM TUBE

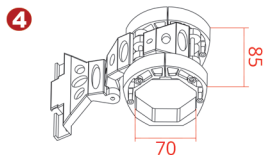
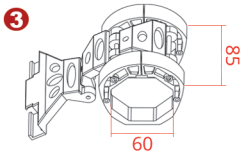

4 **KLT 70.77**

70 MM BORU İÇİN/55,62,77 MM LAMELE GÖRE
55,62,77 MM SLAT SUIT / FOR 70 MM TUBE



LAMEL [PROFİL] TAPALARI SLAT PROFILE CAPS

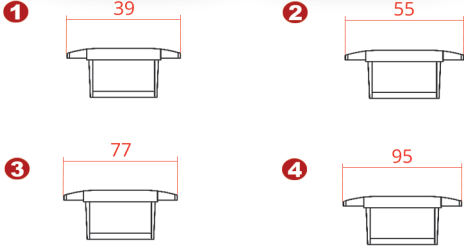

POLİÜRETAN DOLGULU LAMELLER İÇİN TAPALAR SLAT CAPS FOR POLYURETHANE FILLED SLATS

- 1 **TAP POL.39** 39 MM LAMEL
39 MM SLAT
- 2 **TAP POL.55** 55 MM LAMEL
55 MM SLAT
- 3 **TAP POL.77** 77 MM LAMEL
77 MM SLAT
- 4 **TAP POL.95** 95 MM LAMEL
95 MM SLAT

TEKNİK ÖZELLİKLERİ - TECHNICAL DETAILS

ABS HAMMADDE
ABS RAW MATERIAL

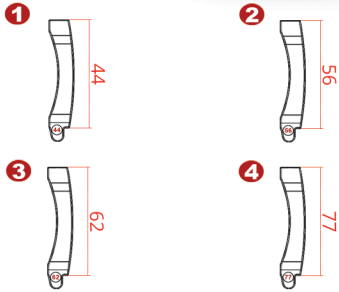

EXTRÜZE LAMELLER İÇİN TAPALAR SLAT CAPS FOR EXTRUDED ALUMINIUMS

- 1 **TAP EXT.44** 44 MM LAMEL
44 MM SLAT
- 2 **TAP EXT.56** 56 MM LAMEL
56 MM SLAT
- 3 **TAP EXT.62** 62 MM LAMEL
62 MM SLAT
- 4 **TAP EXT.77** 77 MM LAMEL
77 MM SLAT

TEKNİK ÖZELLİKLERİ - TECHNICAL DETAILS

ABS HAMMADDE
ABS RAW MATERIAL

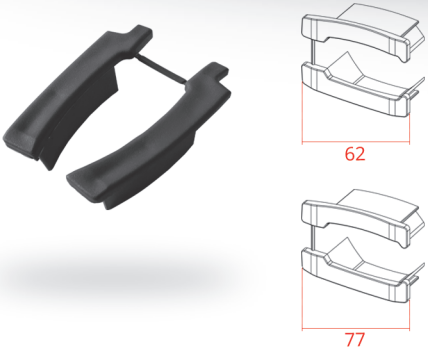

GÖZLÜ EXTRÜZE LAMELLER İÇİN TAPALAR SLAT CAPS FOR HOLLOWED EXTRUDED ALUMINIUMS

- TAP EXT.G62** 62 MM GÖZLÜ PROFİLLER İÇİN
FOR 62 MM HOLLOWED EXTRUDED ALUMINIUMS
- TAP EXT.G77** 77 MM GÖZLÜ PROFİLLER İÇİN
FOR 77 MM HOLLOWED EXTRUDED ALUMINIUMS

TEKNİK ÖZELLİKLERİ - TECHNICAL DETAILS

ABS HAMMADDE
ABS RAW MATERIAL

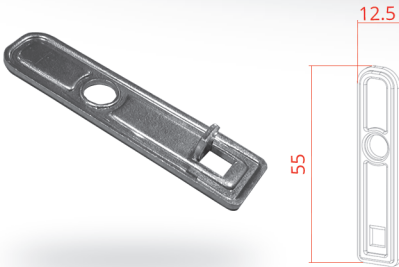

KURŞUN GEÇİRMEZ LAMELLER İÇİN TAPALAR SLAT CAPS FOR BULLET PROOF SLATS

- TAP BLP.50** 50 MM EXTRÜZE KURŞUN GEÇİRMEZ LAMEL İÇİN
FOR 50 MM EXTRUDED BULLET PROOF SLAT

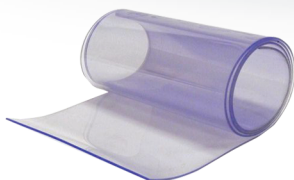

POLİKARBONAT CAMLAR POLYCARBONAT GLASSES

- TAP PLC.77** 77 MM GÖZLÜ PROFİLLER İÇİN
FOR 77 MM HOLLOWED EXTRUDED ALUMINIUMS

TEKNİK ÖZELLİKLERİ - TECHNICAL DETAILS

GÜNEŞ IŞINLARINA DAYANIKLI
RESISTANT TO SUNLIGHT



PANJUR MAKASLARI SHUTTER SCISSORS

MKS M.

PAKETLEME - PACKING

PAKET 10 TAKIM / KOLİ 160 TAKIM
PACK 10 SETS / BOX 160 SETS

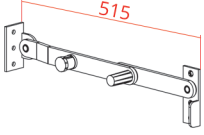

TEKNİK ÖZELLİKLERİ - TECHNICAL DETAILS

ALÜMİNYUM LAMA, METAL UZUN ÖMÜRLÜ KİLİTLEME MEKANİZMASI
ALUMINIUM MATERIAL, METAL LONG LASTING LOCKING MECHANISM

RENK SEÇENEKLERİ - AVAILABLE COLORS



MİNİ PANJUR MAKASLARI MINI TYPE SHUTTER SCISSORS

MKS S.

PAKETLEME - PACKING

PAKET 10 TAKIM / KOLİ 200 TAKIM
PACK 10 SETS / BOX 200 SETS

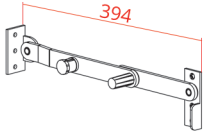

TEKNİK ÖZELLİKLERİ - TECHNICAL DETAILS

ALÜMİNYUM LAMA, METAL UZUN ÖMÜRLÜ KİLİTLEME MEKANİZMASI
ALUMINIUM MATERIAL, METAL LONG LASTING LOCKING MECHANISM

RENK SEÇENEKLERİ - AVAILABLE COLORS

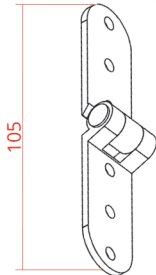

PANJUR MENTEŞELERİ SHUTTER HINGES

MNT S.

PAKETLEME - PACKING

PAKET 100 ADET / KOLİ 1000 ADET
PACK 100PCS. / BOX 1000 PCS.

TEKNİK ÖZELLİKLERİ - TECHNICAL DETAILS

ALÜMİNYUM LAMA
ALUMINIUM MATERIAL

RENK SEÇENEKLERİ - AVAILABLE COLORS

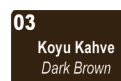
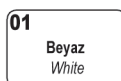



OTOMATİK MAKARALAR AUTOMATIC STRAP BOXES

B1 TİPİ OTOMATİK MAKARALAR B1 TYPE STRAP BOXES

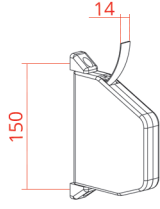

OTM B1-4M.

4 MT KORDON
4 MT STRAP

OTM B1-5M.

5 MT KORDON
5 MT STRAP

OTM B1-5M.01LX

5 MT KORDON / POLYESTER KORDON
5 MT STRAP / POLYESTER STRAP

OTM K1.

KURMALI KORDON
CHARGED STRAP

PAKETLEME - PACKING

PAKET 10 ADET
PACK 10 PCS.

TEKNİK ÖZELLİKLERİ - TECHNICAL DETAILS

UZUN ÖMÜRLÜ SARIM MEKANİZMASI
LONG LASTING CHARGING MECHANISM

RENK SEÇENEKLERİ - AVAILABLE COLORS

01

Beyaz
White

13

Altın Meşe
Golden Oak

03

Koyu Kahve
Dark Brown



BORA EXTRA OTOMATİK MAKARALAR BORA EXTRA TYPE STRAP BOXES

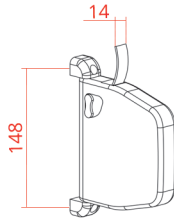

OTM BX-5M.

5 MT KORDON
5 MT STRAP

OTM BX-5M.01LX

5 MT KORDON / POLYESTER KORDON
5 MT STRAP / POLYESTER STRAP

TEKNİK ÖZELLİKLERİ - TECHNICAL DETAILS

UZUN ÖMÜRLÜ SARIM MEKANİZMASI
LONG LASTING CHARGING MECHANISM

PAKETLEME - PACKING

PAKET 20 ADET
PACK 20 PCS.

RENK SEÇENEKLERİ - AVAILABLE COLORS

01

Beyaz
White

13

Altın Meşe
Golden Oak

03

Koyu Kahve
Dark Brown



B2 TİPİ OTOMATİK MAKARALAR B2 TYPE STRAP BOXES

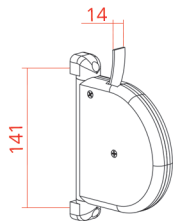
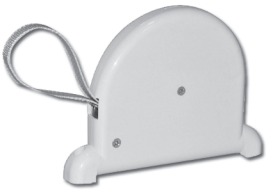

1 OTM B2-4M.

4 MT KORDON
4 MT STRAP

2 OTM B2-5M.

5 MT KORDON
5 MT STRAP

TEKNİK ÖZELLİKLERİ - TECHNICAL DETAILS

UZUN ÖMÜRLÜ SARIM MEKANİZMASI
LONG LASTING CHARGING MECHANISM

PAKETLEME - PACKING

1 PAKET 50 ADET
PACK 50 PCS.

2 PAKET 25 ADET
PACK 25 PCS.

RENK SEÇENEKLERİ - AVAILABLE COLORS

01

Beyaz
White

13

Altın Meşe
Golden Oak

03

Koyu Kahve
Dark Brown





OTOMATİK MAKARALAR AUTOMATIC STRAP BOXES



WİNDE TİPİ OTOMATİK MAKARALAR - KORDONLU WINDE TYPE STRAP BOXES - WITH STRAP

OTM WN-6M.

6 MT KORDON
6 MT STRAP

PAKETLEME - PACKING

PAKET 25 ADET
PACK 25 PCS.

TEKNİK ÖZELLİKLERİ - TECHNICAL DETAILS

UZUN ÖMÜRLÜ SARIM MEKANİZMASI
LONG LASTING CHARGING MECHANISM

STANDART 6 MT
STANDART 6 MT

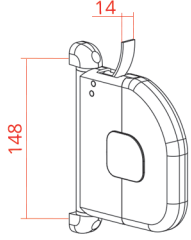

RENK SEÇENEKLERİ - AVAILABLE COLORS



WİNDE TİPİ OTOMATİK MAKARALAR - YUVARLAK İPLİ WINDE TYPE STRAP BOXES - WITH ROUND ROPE

OTM WP-5M.

5 MT YUVARLAK İP
5 MT ROUND ROPE

PAKETLEME - PACKING

PAKET 25 ADET
PACK 25 PCS.

TEKNİK ÖZELLİKLERİ - TECHNICAL DETAILS

UZUN ÖMÜRLÜ SARIM MEKANİZMASI
LONG LASTING CHARGING MECHANISM

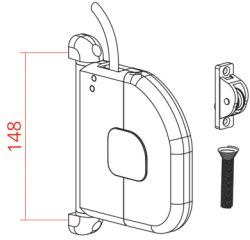

RENK SEÇENEKLERİ - AVAILABLE COLORS

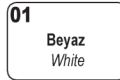

SAC VE PLASTİK MAKARALAR METAL AND PLASTIC ROLLERS

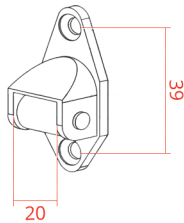

PLASTİK MAKARALAR PLASTIC ROLLERS

MKR S16.

16 MM

PAKETLEME - PACKING

PAKET 100 ADET / KOLİ 2000 ADET
PACK 100 PCS. / BOX 2000 PCS.

RENK SEÇENEKLERİ - AVAILABLE COLORS





SAC VE PLASTİK MAKARALAR METAL AND PLASTIC ROLLERS

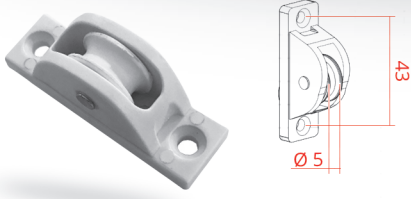

YUVARLAK İPLİ MAKARALAR ROUND ROPES

MKR Y16.

16 MM

OTM WPA.10

YUVARLAK İPLİ OTOMATİK MAKARALAR İÇİN 10 CM YAY
10 CM SPRING FOR ROUNDED ROPE STRAP COILERS

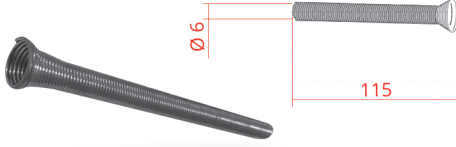

RENK SEÇENEKLERİ - AVAILABLE COLORS

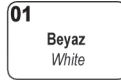

SAC MAKARALAR METAL ROLLERS

MKR M16.

16 MM

MKR M22

22 MM

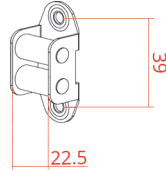
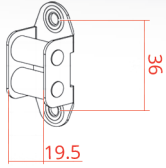

PAKETLEME - PACKING

PAKET 100 ADET / KOLİ 1500 ADET
PACK 100 PCS. / BOX 1500 PCS.

RENK SEÇENEKLERİ - AVAILABLE COLORS

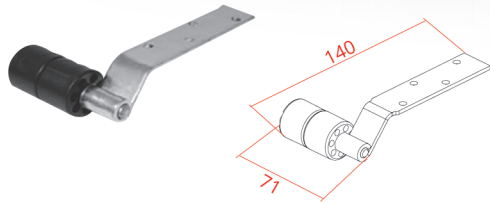
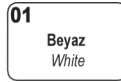

DİKME "U" MAKARASI (62, 77 UYGUN) "U" TYPE ROLLER (62, 77)

DBS MKR.E

62 - 77 MM LAMELLERE UYGUN
SUITABLE FOR 62 - 77 MM SERIES SLATS

PAKETLEME - PACKING

PAKET 150 ADET
PACK 150 PCS.

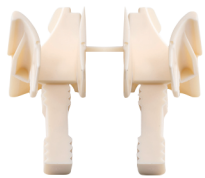

DİKME "U" BAŞI "U" TYPE GUIDE CHANNEL

DBS 39.M

Mini / 39 MM LAMELLERE UYGUN
MINI / SUITABLE FOR 39 MM SERIES SLATS

DBS 55.S

STANDART / 55 - 56 MM LAMELLERE UYGUN
STANDART / SUITABLE FOR 55 - 56 MM SERIES SLATS

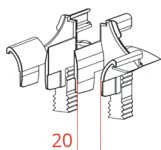
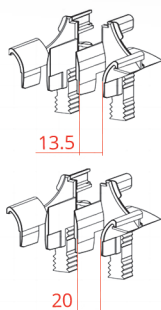



STOPERLER STOPPERS

YUVARLAK TİP (KONİK) STOPERLER ROUND TYPE STOPPERS

STP Y.

PAKETLEME - PACKING

PAKET 100 ADET / KOLİ 2000 ADET
PACK 100 PCS. / BOX 2000 PCS.

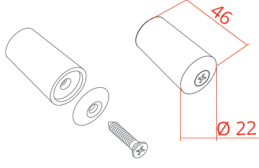

RENK SEÇENEKLERİ - AVAILABLE COLORS

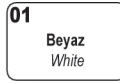

"L" TİPİ STOPERLER "L" TYPE STOPPERS

STP L.

PAKETLEME - PACKING

PAKET 100 ADET / KOLİ 1000 ADET
PACK 100 PCS. / BOX 1000 PCS.

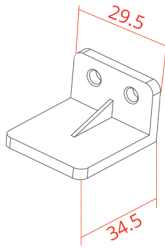

TEKNİK ÖZELLİKLERİ - TECHNICAL DETAILS

ABS HAMMADDE, UV KATKILI
ABS RAW MATERIAL, UV ADDED

RENK SEÇENEKLERİ - AVAILABLE COLORS



GİZLİ PANJUR STOPERLER HIDDEN TYPE STOPPERS

STP G.

PAKETLEME - PACKING

PAKET 200 ADET / KOLİ 5000 ADET
PACK 200 PCS. / BOX 5000 PCS.

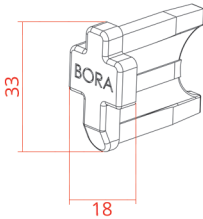

TEKNİK ÖZELLİKLERİ - TECHNICAL DETAILS

ABS HAMMADDE, UV KATKILI
ABS RAW MATERIAL, UV ADDED

RENK SEÇENEKLERİ - AVAILABLE COLORS

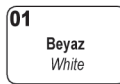

PANJUR KİLİTLERİ SHUTTER LOCKS

KANCALI PANJUR KİLİTLERİ HOOKED SHUTTER LOCKS

KLT 01.

PAKETLEME - PACKING

PAKET 100 ADET
PACK 100 PCS.

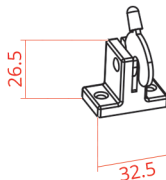

RENK SEÇENEKLERİ - AVAILABLE COLORS

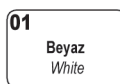

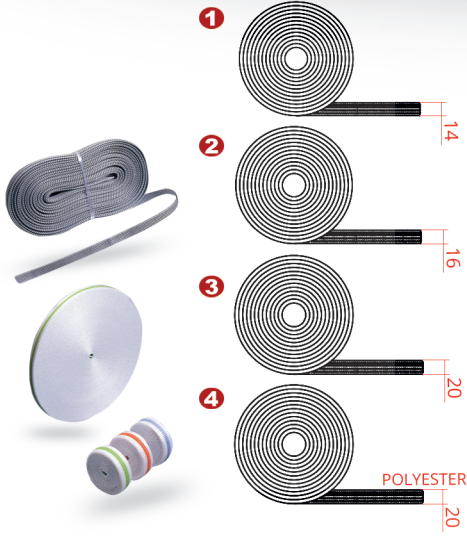

PANJUR KORDONLARI SHUTTER STRAPS

1	KRD 14.MM	14 MM 14 MM
2	KRD 50.MT	16 MM / 50 MT RULO / KOLİ 40 ADET 16 MM / 50 MT ROLL / BOX 40 PCS.
3	KRD 20.MM	20 MM
4	KRD 20.MM / P	20 MM / POLYESTER

PANJUR KILFİTİLLERİ BRUSH GUIDES

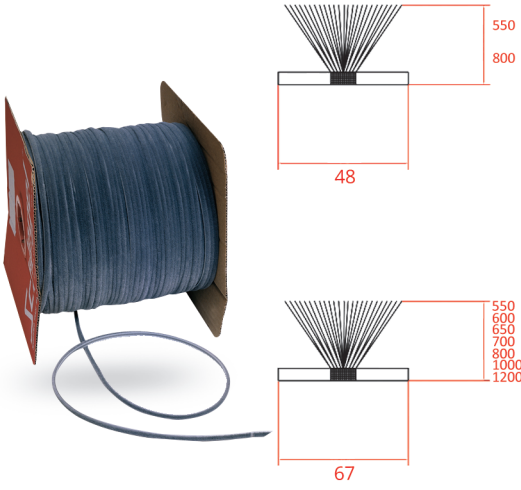

FTL KIL 48.450	48 - 450
FTL KIL 48.800	48 - 800
FTL KIL 67.550	67 - 550
FTL KIL 67.600	67 - 600
FTL KIL 67.650	67 - 650
FTL KIL 67.700	67 - 700
FTL KIL 67.800	67 - 800
FTL KIL 67.1000	67 - 1000
FTL KIL 67.1200	67 - 1200

TEKNİK ÖZELLİKLERİ - TECHNICAL DETAILS

UZUN ÖMÜRLÜ YALITIM
LONG LASTING ISOLATION

LASTİK FİTİLLER LASTIC GUIDES

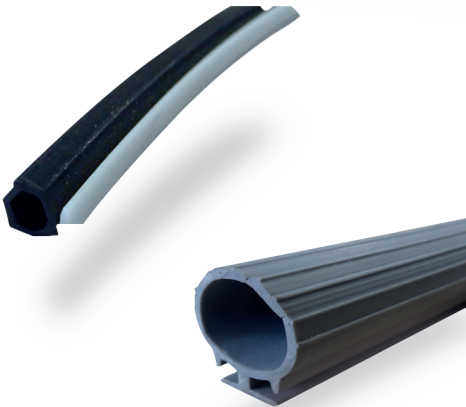

FLT PLS.39	39 MM ALR PARÇALAR İÇİN FOR 39 MM END SLATS
FLT PLS.55	55 MM ALR PARÇALAR İÇİN FOR 55 MM END SLATS
FLT PLS.77	77 MM ALR PARÇALAR İÇİN FOR 77 MM END SLATS
FLT PLS.95	95 MM ALR PARÇALAR İÇİN FOR 95 MM END SLATS



TÜP MOTORLAR TUBULAR MOTORS

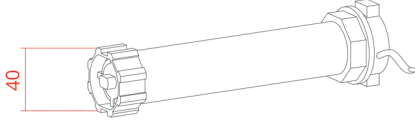
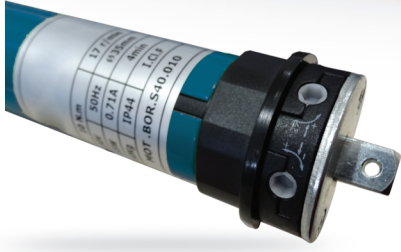

40 MM - TÜP MOTOR 40 MM - TUBULAR MOTOR



S40 - 10

STANDART MOTOR - 10 NM.
STANDART TUBULAR MOTOR - 10 NM.

R40 - 10

RADYO ALICILI MOTOR - 10 NM.
RADIO RECEIVER TUBULAR MOTOR - 10 NM.



Stor Perde
Roller Blind

Perde
Blind

Panjur
Shutter

PAKETLEME - PACKING

PAKET 12 ADET
PACK 12 PCS.

ÜRÜN KODU PRODUCT CODE	TORK TORQUE	GÜÇ POWER	AKIM CURRENT	VOLTAJ VOLTAGE	DÖNÜŞ HIZI RPM	TERMAL KORUMA (DK) THERMAL PROTECT (MIN)	UZUNLUK LENGTH
S40-10	10Nm	165W	0,71A	230V/50Hz	17	4	510mm
R40-10	10Nm	165W	0,71A	230V/50Hz	17	4	610mm

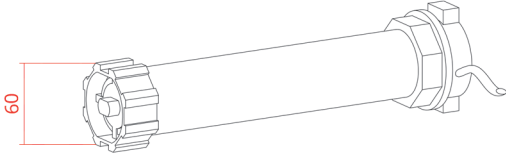

60 MM - TÜP MOTOR 60 MM - TUBULAR MOTOR



S60 - 20

STANDART MOTOR - 20 NM.
STANDART TUBULAR MOTOR - 20 NM.

S60 - 40

STANDART MOTOR - 40 NM.
STANDART TUBULAR MOTOR - 40 NM.

S60 - 50

STANDART MOTOR - 50 NM.
STANDART TUBULAR MOTOR - 50 NM.

M60 - 20

MANUEL (MEKANİK LİMİTLİ) MOTOR - 20 NM.
MANUEL (MECHANICAL LIMITER) TUBULAR MOTOR - 20 NM.

M60 - 40

MANUEL (MEKANİK LİMİTLİ) MOTOR - 40 NM.
MANUEL (MECHANICAL LIMITER) TUBULAR MOTOR - 40 NM.

M60 - 50

MANUEL (MEKANİK LİMİTLİ) MOTOR - 50 NM.
MANUEL (MECHANICAL LIMITER) TUBULAR MOTOR - 50 NM.

R60 - 20

RADYO ALICILI MOTOR - 20 NM.
RADIO RECEIVER TUBULAR MOTOR - 20 NM.

R60 - 40

RADYO ALICILI MOTOR - 40 NM.
RADIO RECEIVER TUBULAR MOTOR - 40 NM.

R60 - 50

RADYO ALICILI MOTOR - 50 NM.
RADIO RECEIVER TUBULAR MOTOR - 50 NM.

E60 - 20

ELEKTRONİK LİMİTLİ MOTOR - 20 NM.
ELECTRONIC LIMITER TUBULAR MOTOR - 20 NM.

E60 - 50

ELEKTRONİK LİMİTLİ MOTOR - 50 NM.
ELECTRONIC LIMITER TUBULAR MOTOR - 50 NM.



Tente
Awning

Stor Perde
Roller Blind

Panjur
Shutter

ÜRÜN KODU PRODUCT CODE	TORK TORQUE	GÜÇ POWER	AKIM CURRENT	VOLTAJ VOLTAGE	DÖNÜŞ HIZI RPM	TERMAL KORUMA (DK) THERMAL PROTECT (MIN)	UZUNLUK LENGTH
S60-20	20Nm	178W	0,78A	230V/50Hz	17	4	480mm
S60-40	40Nm	276W	1,20A	230V/50Hz	17	4	580mm
S60-50	50Nm	282W	1,23A	230V/50Hz	17	4	580mm
M60-20	20Nm	178W	0,78A	230V/50Hz	17	4	520mm
M60-40	40Nm	276W	1,20A	230V/50Hz	17	4	620mm
M60-50	50Nm	282W	1,23A	230V/50Hz	17	4	620mm
R60-20	20Nm	178W	0,78A	230V/50Hz	17	4	580mm
R60-40	40Nm	276W	1,20A	230V/50Hz	17	4	680mm
R60-50	50Nm	282W	1,23A	230V/50Hz	17	4	680mm
E60-20	20Nm	178W	0,78A	230V/50Hz	17	4	480mm
E60-40	40Nm	276W	1,20A	230V/50Hz	17	4	580mm



70 MM - TÜP MOTORLAR
70 MM - TUBULAR MOTORS

M70 - 80

MANUEL (MEKANİK LİMİTLİ) MOTOR - 80 NM.
MANUEL (MECHANICAL LIMITER) TUBULAR MOTOR - 80 NM.

M70 - 120

MANUEL (MEKANİK LİMİTLİ) MOTOR - 120 NM.
MANUEL (MECHANICAL LIMITER) TUBULAR MOTOR - 120 NM.

M70 - 140

MANUEL (MEKANİK LİMİTLİ) MOTOR - 140 NM.
MANUEL (MECHANICAL LIMITER) TUBULAR MOTOR - 140 NM.

E70 - 140

ELEKTRONİK LİMİTLİ MOTOR - 140 NM.
ELECTRONIC LIMITER TUBULAR MOTOR - 140 NM.



Stor Perde
Roller Blind

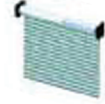

Panjur
Shutter

PAKETLEME - PACKING

PAKET 4 ADET
PACK 4 PCS.

ÜRÜN KODU PRODUCT CODE	TORK TORQUE	GÜÇ POWER	AKIM CURRENT	VOLTAJ VOLTAGE	DÖNÜŞ HIZI RPM	TERMAL KORUMA (DK) THERMAL PROTECT (MIN)	UZUNLUK LENGTH
M70-80	80Nm	350W	1,50A	230V/50Hz	17	4	680mm
M70-120	120Nm	450W	1,96A	230V/50Hz	17	4	680mm
M70-140	140Nm	450W	1,96A	230V/50Hz	17	4	680mm



102 MM - TÜP MOTORLAR
102 MM - TUBULAR MOTORS

M102 - 230

MANUEL (MEKANİK LİMİTLİ) MOTOR - 230 NM.
MANUEL (MECHANICAL LIMITER) TUBULAR MOTOR - 230 NM.

M102 - 300

MANUEL (MEKANİK LİMİTLİ) MOTOR - 300 NM.
MANUEL (MECHANICAL LIMITER) TUBULAR MOTOR - 300 NM.

M102 - 330

MANUEL (MEKANİK LİMİTLİ) MOTOR - 330 NM.
MANUEL (MECHANICAL LIMITER) TUBULAR MOTOR - 330 NM.

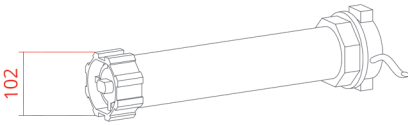

Panjur
Shutter

PAKETLEME - PACKING

PAKET 2 ADET
PACK 2 PCS.

ÜRÜN KODU PRODUCT CODE	TORK TORQUE	GÜÇ POWER	AKIM CURRENT	VOLTAJ VOLTAGE	DÖNÜŞ HIZI RPM	TERMAL KORUMA (DK) THERMAL PROTECT (MIN)	UZUNLUK LENGTH
M102-230	230Nm	810W	3,6A	230V/50Hz	17	4	570mm
M102-300	300Nm	830W	3,8A	230V/50Hz	17	4	600mm
M102-330	330Nm	880W	4,0A	230V/50Hz	17	4	600mm

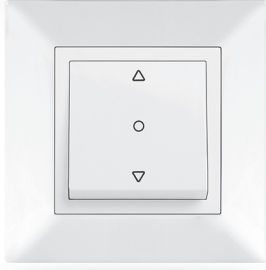

SIVA ÜSTÜ İKİ YÖNLÜ BUTON SURFACE SWITCH BUTTON - BIDIRECTIONAL

MOT.AKS.BUT.S2X

SIVA ÜSTÜ İKİ YÖNLÜ BUTON
SURFACE SWITCH BUTTON - BIDIRECTIONAL



ALICI SETLERİ RECEIVERS

1 MOT.AKS.RAD.2KU

RADYO ALICI + 2'Lİ KUMANDA SETİ
RADIO RECEIVER + 2 REMOTE CONTROL

2 MOT.AKS.RAD.M

MİNİ RADYO ALICISI
MINI RADIO RECEIVER



KUMANDALAR TRANSMITTERS - EMITTERS

1 MOT.AKS.KUM.TEK

İLAVE - TEKLİ KUMANDA (2 KANALLI)
EXTRA ONE REMOTE BUTTON (2 CHANNEL)

2 MOT.AKS.KUM.COK

İLAVE - TEKLİ KUMANDA (4 KANALLI)
EXTRA ONE REMOTE BUTTON (4 CHANNEL)

3 MOT.AKS.KUM.1-16CH

İLAVE - TEKLİ KUMANDA LUX SERİ (1 - 16 KANALLI)
EXTRA ONE REMOTE BUTTON LUX SERIES (1 - 16 CHANNEL)



GÜÇ KAYNAKLARI POWER SUPPLIERS

AKS.POW.WAT.100

220- 230 V PANJUR / KEPENK - GÜÇ KAYNAĞI - 1000 W
220-230 V SHUTTER POWER SUPPLIER - 1000 W

AKS.POW.WAT.170

220- 230 V PANJUR / KEPENK - GÜÇ KAYNAĞI - 1700 W
220-230 V SHUTTER POWER SUPPLIER - 1700 W

MOT.AKS.KUM.POW

GÜÇ KAYNAĞI - İLAVE KUMANDA
POWER SUPPLIER - EXTRA REMOTE CONTROL

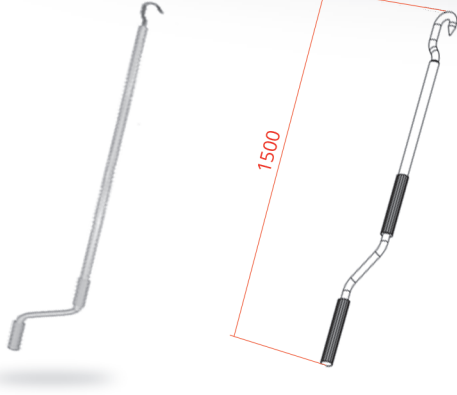

KANCALI REDÜKTÖR KOLLARI HANDCRANKS WITH HOOK

MOT.AKS.RED.150

KANCALI REDÜKTÖR KOLU L=1500MM
HANDCRANK WITH HOOK - L = 1500 MM

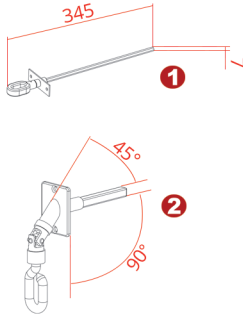

KANCALI ARA KOLLAR JOINTS WITH EYE

1 MOT.AKS.RED.SBT

KANCALI SEKİZGEN ARA KOL - SABİT
JOINT WITH EYE OCTAGONAL - FIXED

2 MOT.AKS.RED.X90

KANCALI SEKİZGEN ARA KOL - 90 DERECE
JOINT WITH EYE OCTAGONAL - 90 DEGREE

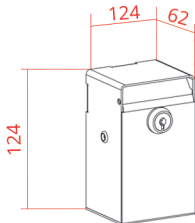

KİLİTLİ REDÜKTÖR KUTUSU SAFETY LOCKABLE BOX FOR HANDCRANK

KLT RKT.

RENK SEÇENEKLERİ - AVAILABLE COLORS

01

Beyaz
White

02

Metalik Gri
Metallic Grey

13

Altın Meşe
Golden Oak

03

Koyu Kahve
Dark Brown

BL

Siyah
Black



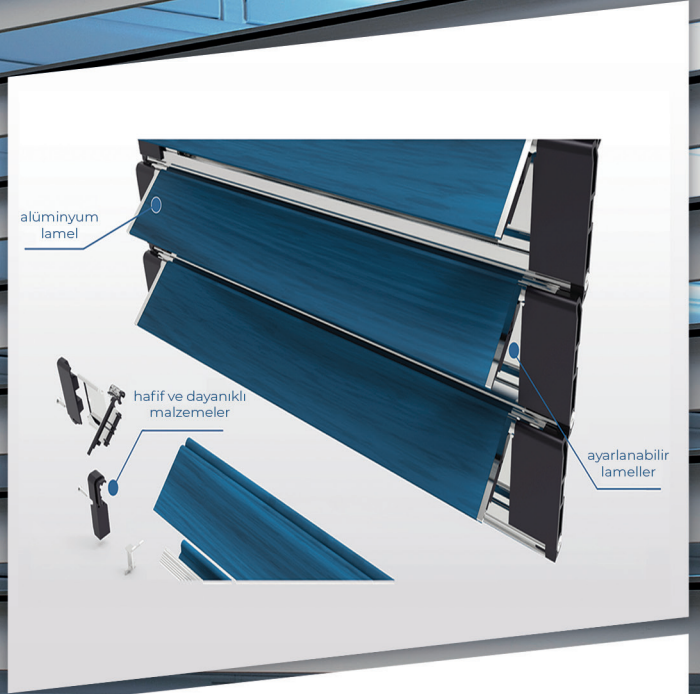

BORA PANJUR

AYARLANABİLİR JALUZİ FONKSİYONLU PANJUR SİSTEMİ

THE ADJUSTABLE
BLADES ROLLING
SHUTTER WITHOUT
ROTATION MECHANISM



35 Yılın Tecrübesi, Geleceğin Teknolojisi ...
Experience of 30 years, Technology of Future ...



AYARLANABİLİR JALUZİ FONKSİYONLU PANJUR SİSTEMİ

THE ADJUSTABLE BLADES ROLLING SHUTTER WITHOUT ROTATION MECHANISM



BOR-SL

SABİT LAMELLER
FIXED BLADES
ПРОСТЫЕ ЛАМЕЛИ



BOR-ML

MOBİL LAMELLER
(DIŞA AÇILAN)
MOBILE SLATS (OUTWARD OPEN)
ФОНКЦИОННЫЕ ЛАМЕЛИ



BOR-T

TELESKOPİK ALT PARÇA
TELESCOPIC END PART
ТЕЛЕСКОПИЧЕСКИЙ КОНЦЕВОЙ ПРОФИЛЬ

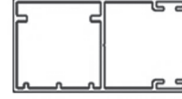

BOR-YP

YAN DİKME PROFİLİ
SIDE COLUMN PROFILE
БОКОВАЯ НАПРАВЛЯЮЩАЯ



BOR-SLS

ARA DESTEK PROFİLİ
INNER SUPPORT PROFILE
ПРОФИЛЬ ВСПОМОГАТЕЛЬНЫЙ МЕЖДУ ЛАМЕЛЕЙ

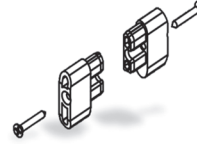

KIT-ST

SABİT LAMEL TAPASI
CAPS FOR FIXED SLATS
БОКОВЫЕ ЗАМКИ ПРОСТОГО ЛАМЕЛЯ



BOR-AP

ALT PARÇA PROFİLİ
END SLAT PROFILE
КОНЦЕАОЙ ПРОФИЛЬ

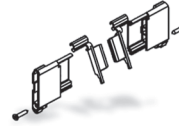

KIT-YT

YAN TAPA TAKIMI - PLASTİK
SIDE CAP SET - PLASTIC
КОМПЛЕКТ БОКОВЫХ ЗАМКОВ ФОНКЦИОННЫХ ЛАМЕЛЕЙ

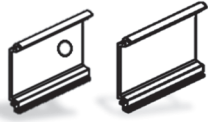

KIT - OBT

BÖLME / DESTEK TAPASI
(ALÜMİNYUM)
DIVIDER / CENTRAL SUPPORT CAP - ALUMINIUM
ВСПОМОГАТЕЛЬНЫЕ ПРОФИЛИ

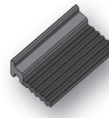

KIT - CNT

MOBİL LAMEL CONTASI
MOBILE SLAT GASKET
РЕЗИНА ДЛЯ ФОНКЦИОННЫХ ЛАМЕЛЕЙ

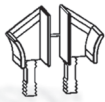

KIT-DB

DİKME KANALI KLAVUZ PARÇASI
GUIDE FOR SIDE PROFILE
УНИВЕРСАЛЬНЫЙ КАНАЛ БОКОВЫХ НАПРАВЛЯЮЩИХ

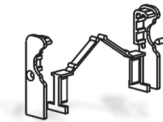

KIT-APT

ALT PARÇA PROFİL TAPASI
BOTTOM PROFILE CAPS
БОКОВЫЕ ЗАМКИ НИЖНЕГО ПРОФИЛЯ



20 Nm. ELEKTRONİK LİMİTLİ MOTOR
20 Nm. ELECTRONIC LIMIT MOTOR

MOT.BOR.E60.020

40 Nm. ELEKTRONİK LİMİTLİ MOTOR
40 Nm. ELECTRONIC LIMIT MOTOR

MOT.BOR.E60.040

80 Nm. ELEKTRONİK LİMİTLİ MOTOR
80 Nm. ELECTRONIC LIMIT MOTOR

MOT.BOR.E70.080

120 Nm. ELEKTRONİK LİMİTLİ MOTOR
120 Nm. ELECTRONIC LIMIT MOTOR

MOT.BOR.E70.120



TEK KANALLI KUMANDA
ONE CHANNEL REMOTE

MOT.AKS.KUM.1CH

5 KANALLI KUMANDA
5 CHANNEL REMOTE

MOT.AKS.KUM.5CH

10 KANALLI KUMANDA
10 CHANNEL REMOTE

MOT.AKS.KUM.10CH





155 - 185 mm MONOBLOK SİSTEM AKSEUARLARI

155- 185 mm MONOBLOCK (PLASTIC) SYSTEMS ACCESSORIES

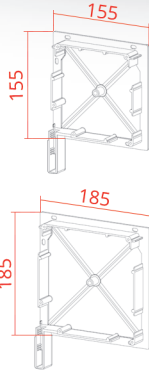

PLASTİK YAN KAPAKLAR PLASTIC SIDE CAP

YKP PS155

155x155 PLASTİK YAN KAPAK
155x155 PLASTIC SIDE CAP

YKP PS185

185x185 PLASTİK YAN KAPAK
185x185 PLASTIC SIDE CAP

PAKETLEME - PACKING

PAKET 30 TAKIM
BOX 30 SET

RENK SEÇENEKLERİ - AVAILABLE COLORS

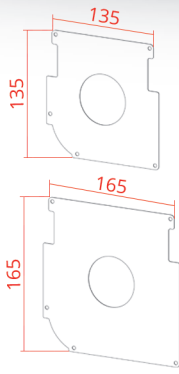
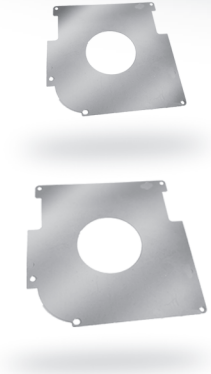
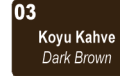

YAN KAPAK İÇİ SAC SEPERATÖR INNER PROTECTIVE PART FOR SIDE CAP

YKP MUH155

SAC SEPERATÖR 155x155 MM YAN KAPAK İÇİN
INNER PROTECTIVE PART FOR 155x155 MM SIDE CAP

YKP MUH185

SAC SEPERATÖR 185x185 MM YAN KAPAK İÇİN
INNER PROTECTIVE PART FOR 185x185 MM SIDE CAP

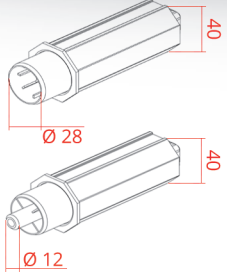

SEKİZGEN BORU BAŞLARI - 40 MM OCTAGONAL TUBE CAPS - 40 MM

BRB TR40.28

TELESKOPIK 28/12 MM RULMAN YUVALI
TELESCOPIC 28/12 MM WITH BALL BEARING HOLE

BRB TP40.12

TELESKOPIK 12 MM PİMLİ
TELESCOPIC 12 MM PIVOT

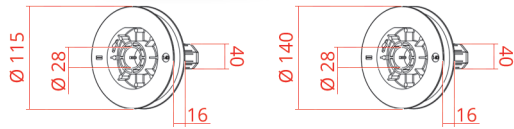
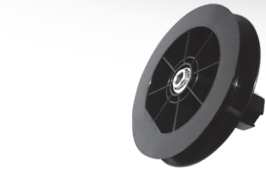

SEKİZGEN PLASTİK KASNAKLAR - RULMAN YUVALI OCTAGONAL PLASTIC PULLEYS - WITH BEARING HOLE

KAS R.115

115 MM

KAS R.140

140 MM

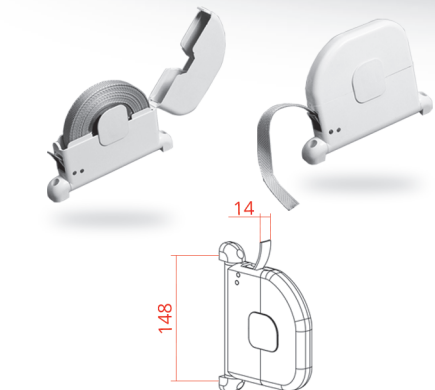

WİNDE TİPİ OTOMATİK MAKARALAR - KORDONLU WINDE TYPE STRAP BOXES - WITH STRAP

OTM WN-6M.

6 MT KORDON
6 MT STRAP

PAKETLEME - PACKING

PAKET 25 ADET
PACK 25 PCS.

TEKNİK ÖZELLİKLERİ - TECHNICAL DETAILS

UZUN ÖMÜRLÜ SARIM MEKANİZMASI
LONG LASTING CHARGING MECHANISM

STANDART 6 MT. İSTEĞE GÖRE 4 MT. VEYA 5 MT. YAPILABİLİR.
STANDART 6 MT. OPTIONALLY 4 MT. OR 5 MT.



155 - 185 mm MONOBLOK SİSTEM AKSEUARLARI

155- 185 mm MONOBLOCK (PLASTIC) SYSTEMS ACCESSORIES

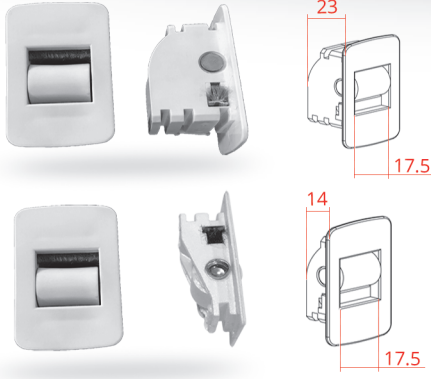

FIRÇALI MAKARALAR BRUSH ROLLERS

MKR F16-23

FIRÇALI MAKARA 16 MM ALÜMİNYUM KUTU İÇİN
16 MM BRUSHED GUIDE ROLL FOR ALUMINIUM BOX

MKR F16-14

FIRÇALI MAKARA 16 MM MONOBLOK İÇİN
16 MM BRUSHED GUIDE ROLL FOR MONOBLOCK

RENK SEÇENEKLERİ - AVAILABLE COLORS

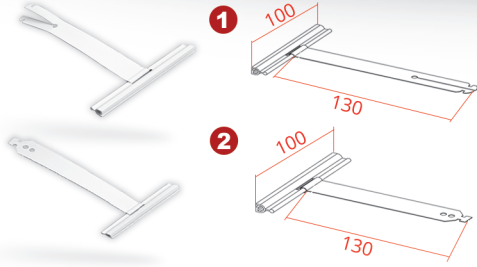
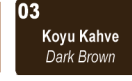

ÇELİK PANJUR ASKISI - 130 MM STEEL SLAT HANGER - 130 MM

1 PAS 130.G

GEÇMELİ
BY INSERTING

2 PAS 130.V

VİDALI
BY SCREWING

TEKNİK ÖZELLİKLERİ - TECHNICAL DETAILS

ÇELİK YAY
STEEL SPRING

PAKETLEME - PACKING

PAKET 100 ADET
PACK 100 PCS.

YUVARLAK TİP (KONİK) STOPERLER ROUND TYPE STOPPERS

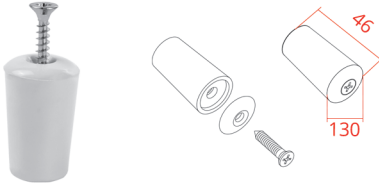

STP Y.

PAKETLEME - PACKING

PAKET 100 ADET / KOLİ 1000 ADET
PACK 100 PCS. / BOX 1000 PCS.

RENK SEÇENEKLERİ - AVAILABLE COLORS

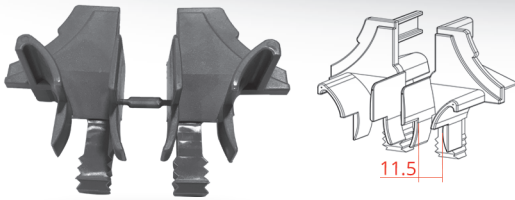
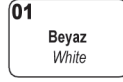

DİKMELİ "U" BAŞI PLASTİK KAPAK UYUMLU "U" TYPE GUIDE CHANNEL SUITABLE FOR PLASTIC SIDE CAP

DBS PSC.

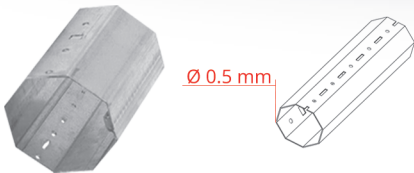

SEKİZGEN GALVANİZ BORU - Ø 40 MM OCTAGONAL GALVANIZED TUBE DIA. 40 MM Ø

BOR G40.50

0.50 MM KALINLIK
0.50 MM THICKNESS

PAKETLEME - PACKING

PAKET 10 BOY
PACK 10 PCS.

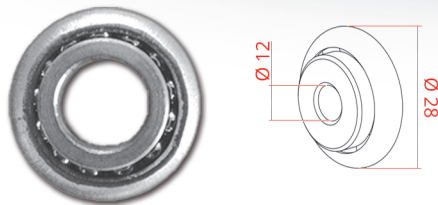

28 MM RULMAN - 12 MM DELİK ÇAPI 28 MM BALL BEARING - HOLE DIA. 12 MM

RLM 28.12

MONOBLOK PANJUR SİSTEMLERİ

MONOBLOCK SHUTTER SYSTEMS

Monoblok panjur sistemleri son teknolojik makinelerle, her iklim şartına uyum sağlayacak şekilde tasarlanmış farklı kutu seçenekleri ile üretimin her noktasında deneyimli personellerle kalite kontrol aşamasından geçerek üretilmektedir

Monoblock shutter systems with latest technology machines, designed to adapt to any climate with a choice of different boxes with experienced staff in every process of production is produced through a series of quality control.



shutter solutions since 1984...

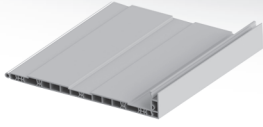

MONOBLOK KUTU DIŞ-ÜST-ARKA PROFİLLERİ MONOBLOCK BOX OUTER-UPPER-BACK PROFILES

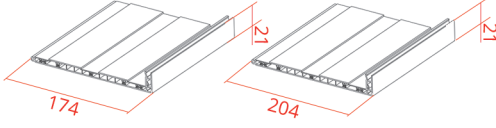

MNB 195KT.

195 MM * 195 MM

MNB 225KT.

225 MM * 225 MM

PAKETLEME - PACKING

PAKET 48 METRE
PACK 48 METER

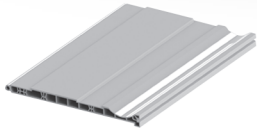

MONOBLOK KUTU ALT PROFİLLERİ MONOBLOCK BOX BOTTOM PROFILES

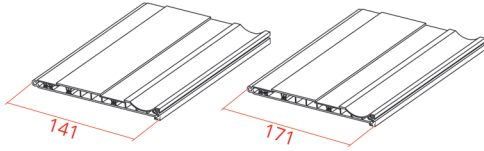

MNB 195A.

195 MM * 195 MM

MNB 225A.

225 MM * 225 MM

PAKETLEME - PACKING

PAKET 48 METRE
PACK 48 METER

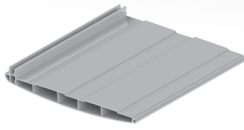

MONOBLOK KUTU OVAL PROFİLLER VE KAPAKLARI MONOBLOCK BOX ROUND PROFILES AND COVERS

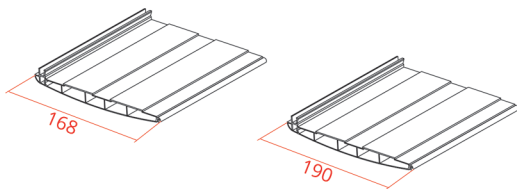

MNB 195VL.

195 MM * 195 MM

MNB 225VK.

225 MM * 225 MM

PAKETLEME - PACKING

PAKET 30 ADET
PACK 30 PCS.

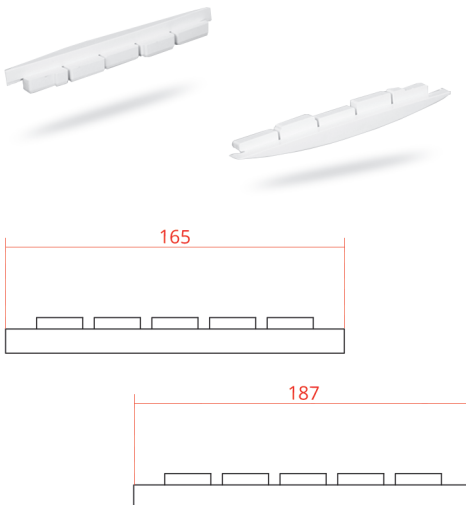



YAN KAPAK VE ORTA BÖLME SETLERİ SIDE CAP AND MIDDLE DIVIDE SETS

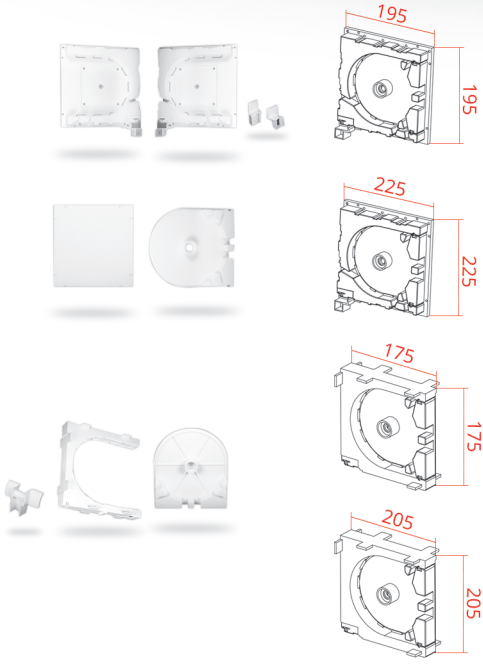

MNB 195YK.

195 MM * 195 MM / YAN KAPAK SETİ
195 MM * 19,5 MM / SIDE COVER SET

MNB 225YK.

225 MM * 225 MM / YAN KAPAK SETİ
225 MM * 225 MM / SIDE COVER SET

PAKETLEME - PACKING

HER PAKET 25 TAKIM
EACH PACK 25 SET

MNB 195MD.

195 MM * 195 MM / ORTA BÖLME SETİ
195 MM * 195 MM / MIDDLE DIVIDE SET

MNB 225MD.

225 MM * 225 MM / ORTA BÖLME SETİ
225 MM * 225 MM / MIDDLE DIVIDE SET

PAKETLEME - PACKING

PAKET 25 TAKIM
PACK 25 SET



PLASTİK YAN RAYLAR PLASTIC SIDE RAILS

MNB YD39.

39 MM LAMELE GÖRE
SUITABLE FOR 39 MM SLATS

MNB YD55.

55 MM LAMELE GÖRE
SUITABLE FOR 55 MM SLATS

PAKETLEME - PACKING

HER PAKET 39 LUK : 48 METRE
EACH PACK FOR 39 : 48 METER

HER PAKET 55 LİK : 18 METRE
EACH PACK FOR 55 : 18 METER

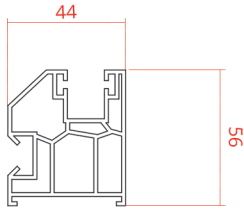

PLASTİK ORTA RAYLAR PLASTIC MIDDLE RAILS

MNB OD39.

39 MM LAMELE GÖRE
SUITABLE FOR 39 MM SLATS

MNB OD55.

55 MM LAMELE GÖRE
SUITABLE FOR 55 MM SLATS

PAKETLEME - PACKING

HER PAKET 39 LUK : 18 METRE
EACH PACK FOR 39 : 18 METER

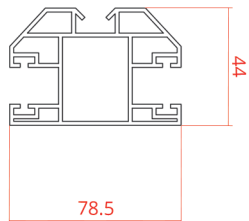



KORDON YAN VE ORTA GEÇİŞ YÜZÜKLERİ CORDON TRANSATION RINGS

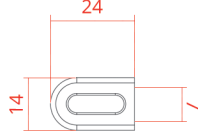

MNB YGY.

YAN GEÇİŞ YÜZÜĞÜ
LATERAL CORDON TRANSITION RING

PAKETLEME - PACKING

PAKET 100 ADET
PACK 100 PCS.

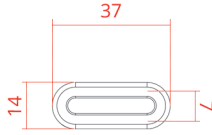

MNB OGY.

ORTA GEÇİŞ YÜZÜĞÜ
MIDDLE CORDON TRANSITION RING

PAKETLEME - PACKING

PAKET 100 ADET
PACK 100 PCS.

PLASTİK PANJUR TAMAMLAYICI AKSESUARLAR OTHER PLASTIC ACCESSORIES

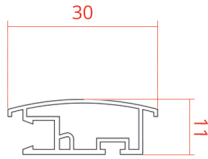

MNB TPC.

TAMPON ÇİTASI
BUMPER BEAD

PAKETLEME - PACKING

PAKET 100 MT
PACK 100 MT



MNB VID.MTL

NİPEL VİDASI
RAIL CONNECTION SCREW

PAKETLEME - PACKING

PAKET 10.000 ADET
PACK 10.000 PCS.

RENK SEÇENEKLERİ - AVAILABLE COLORS

01

Beyaz
White

GO

Altın Meşe
Golden Oak

NU

Maun Ahşap
Mahogany Wood



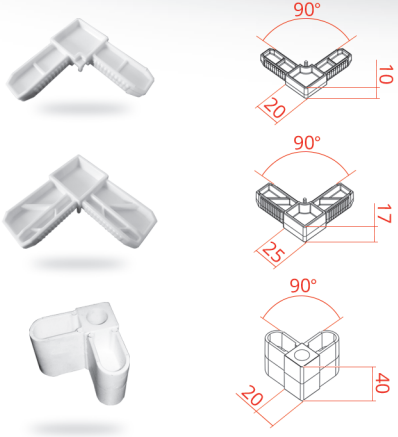

SİNEKLİK KÖŞE TAKOZLARI SCREENING CORNER CHOCKS

- | | | |
|---|-----------------|---------|
| 1 | SIN 01-1 | 10 * 20 |
| 2 | SIN 01-2 | 17 * 25 |
| 3 | SIN 02 | 20 * 40 |

PAKETLEME - PACKING

- | | |
|---|---|
| 1 | PAKET 10*20 : 100 ADET
PACK 10*20 : 100 PCS. |
| 2 | PAKET 17*25 : 100 ADET
PACK 17*25 : 100 PCS. |
| 3 | PAKET 20*40 : 50 ADET
PACK 20*40 : 50 PCS. |



SİNEKLİK MENTEŞELERİ SCREENING HINGES

- | | |
|-----------------|---------|
| SIN 03-1 | 10 * 20 |
| SIN 03-2 | 17 * 25 |

PAKETLEME - PACKING

PAKET 100 ADET
PACK 100 PCS.

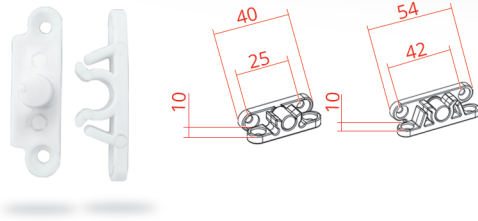

SİNEKLİK ÇİTÇITLARI SCREENING CLIPS

- | | |
|-----------------|------------------------------------|
| SIN 04-1 | 10 * 20 / KÜÇÜK
10 * 20 / SMALL |
| SIN 04-2 | 17 * 25 / BÜYÜK
17 * 25 / BIG |

PAKETLEME - PACKING

PAKET 100 ADET
PACK 100 PCS.

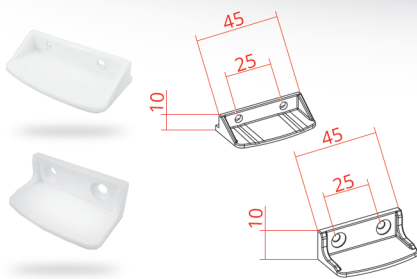

SİNEKLİK TUTAMAKLAR SCREENING HANDLES

- | | |
|-----------------|------------------------------------|
| SIN 05-1 | 10 * 20 / KÜÇÜK
10 * 20 / SMALL |
| SIN 05-2 | 17 * 25 / BÜYÜK
17 * 25 / BIG |

PAKETLEME - PACKING

PAKET 100 ADET
PACK 100 PCS.

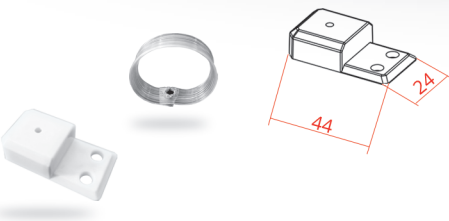

SİNEKLİK TUTMA HALKASI VE ALTI SCREENING HOLDER RING & BASE

- | | |
|-----------------|---|
| SIN 06 | SİNEKLİK TUTMA HALKASI
SCREENING HOLDER RING |
| SIN 06-1 | SİNEKLİK TUTMA HALKASI ALTI
SCREENING HOLDER RING BASE |

PAKETLEME - PACKING

PAKET 100 ADET
PACK 100 PCS.

RENK SEÇENEKLERİ - AVAILABLE COLORS

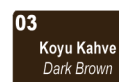
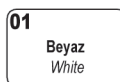

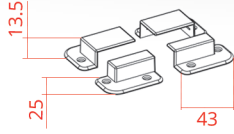

SİNEKLİK BAĞLAMA PABUÇLARI SCREENING BINDER PADS

SIN 07-1

10 * 20

PAKETLEME - PACKING

PAKET 50 ADET
PACK 50 PCS.

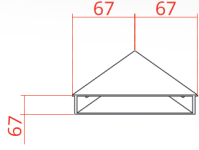

SİNEKLİK KÖŞE MUKAVEMET TAKOZU SCREENING CORNER SUPPORT CHOCK

SIN 08

PAKETLEME - PACKING

PAKET 100 ADET
PACK 100 PCS.

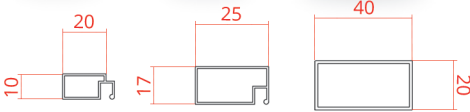
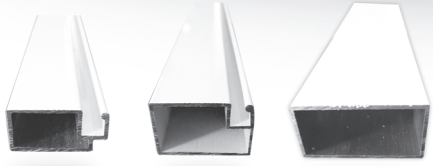

SİNEKLİK ALÜMİNYUM PROFİLLERİ SCREENING ALUMINIUM PROFILES

SIN AL-1

10 * 20

SIN AL-2

17 * 25

SIN AL-3

20 * 40

PAKETLEME - PACKING

10*20 PAKET : 120 METRE
10*20 PACK : 120 METER

17*25 PAKET : 120 METRE
17*25 PACK : 120 METER

20*40 PAKET : 60 METRE
20*40 PACK : 60 METER

RENK SEÇENEKLERİ - AVAILABLE COLORS



SİNEKLİK FİTİLİ ÇEKME APARATI SCREENING SPLINE ROLLER

SIN 09

PAKETLEME - PACKING

PAKET 30 ADET
PACK 30 PCS.



SİNEKLİK FİTİLLERİ SCREENING GASKETS

SIN F40

4.00 MM

SIN F45

4.50 MM

SIN F50

5.00 MM

SIN F60

6.00 MM

PAKETLEME - PACKING

PAKET 100 METRE
PACK 100 METER.



SİNEKLİK TÜLLERİ (FİBERGLASS) SCREENING MESH (FIBERGLASS)

SIN T80

80 CM - 30 MT.

SIN T100

100 CM - 30 MT.

SIN T120

120 CM - 30 MT.

SIN T140

140 CM - 30 MT.

SIN T160

160 CM - 30 MT.

SIN T180

180 CM - 30 MT.

TÜP MOTOR KALDIRMA KUVVETLERİ

Tüm motorların kaldırma kapasitesi Newton'un Hareket Yasası'na göre hesaplanır. Özet olarak, Newton yasasında belirtilen Tork (NM) değerinin motor çapı ve ağırlıkla oranıtısı anlatılmıştır. Teorik kaldırma kapasitesi malzeme çeşidi, sürtünme payı, panjurun genişlik ve yüksekliği, kurulum tekniği ve aksesuarlardan dolayı değişmektedir.

Aşağıda belirtilen tablo, Newton Hareket Yasası'na göre ayarlanmış olup yukarıda belirtilen teorik faktörlerin yani bu da yaklaşık %25 lik standart bir oranın fazlasını içermemektedir. Bu tablo basitçe motorların yalın kaldırma kapasitelerini göstermektedir. Siz ölçülerinizi hesap ederken %25lik teorik payı da ilave edip o şekilde kontrol ediniz.

TUBULAR MOTOR LIFTING CAPACITY CHART

The Lifting capacity of all motors is based on Newton's Law of Motion. In Summary, Newton's Law of Motion states that Torque (Nm) equals the Radius of the Tubular Motor times the Weight being lifted. The theoretical lifting capacity is reduced by several factors, such as material dimensions (height and thickness of slats), friction of material in the track, length and height of the curtain, installation techniques and accessories (end retention slat locks).

The lifting capacity chart below is based on Newton's Law of Motion and not includes % 25 reduction of the theoretical capacity to compensate for the factors described above. This chart is provided as an indicator of the amount of weight each motor can lift. The actual capacity depends on the amount environment the external factors deviate from the theoretical.

MOTOR SERİSİ SERIES	(Nm)	Ø MOTOR ÇAP / MOTOR DIA.												
		Ø 40	Ø 50	Ø 60	Ø 70	Ø 80	Ø 90	Ø 102	Ø 110	Ø 120	Ø 130	Ø 140	Ø 150	Ø 160
S40, R40	3	10	8											
	6	19	16											
	8	26	21											
	10	33	26	22										
	12	38	29	25										
S60, M60, R60, E60	10			21	17									
	20			44	38									
	30			66	56									
	40			88	75	66								
	50			110	90	82	73							
S70, M70, R70	60				113	99	88							
	80				151	132	117	105						
	100				189	165	147	132	120					
	120				225	198	178	159	144	132	122			
	140				260	232	206	185	168	155	142			
S102, M102	180							238	216	198	183	170	159	
	230								304	277	254	234	217	203
	280								371	337	309	285	265	247
	300								397	361	331	305	284	245
	330								437	397	364	338	312	291

Lamel Boyut Grafikleri

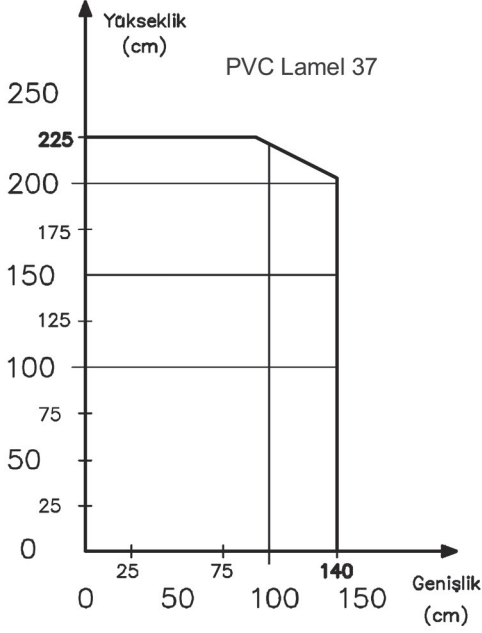

MONOBLOK PANJUR SARIM ÇAPLARI MONOBLOCK SHUTTER ROLLING DIAMETER INFO

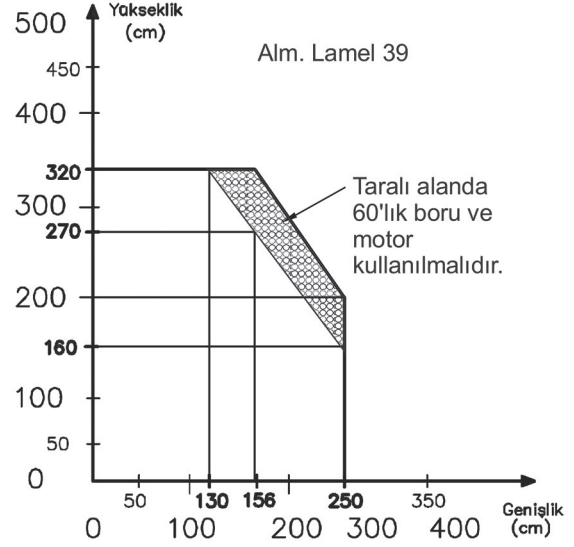

Lamel Sarım Tablosu

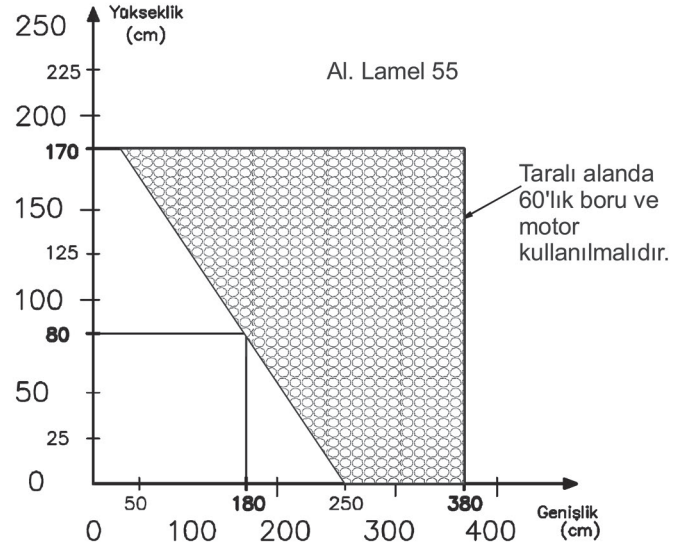
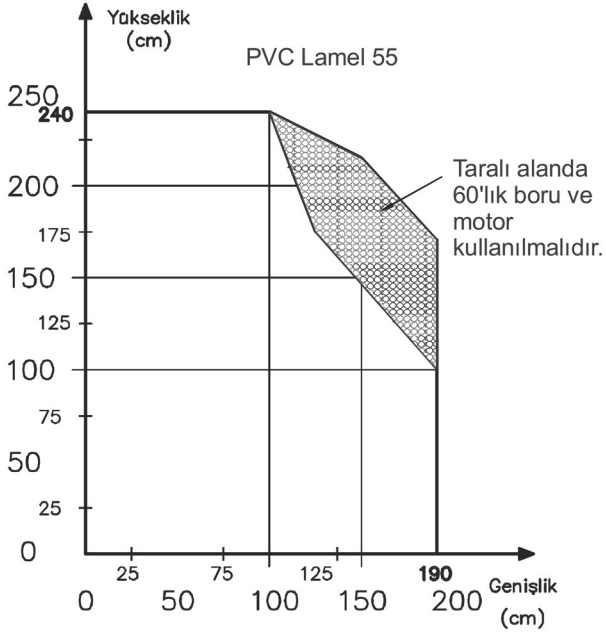

Lamel Sarım Tablosu

Kutu Ölçüleri		195x195 mm Kutu		195x225 mm İzl. Kutu		225x225 mm Kutu	
Lamel Cinsi	Boru Cinsi	Ø 40	Ø 60	Ø 40	Ø 60	Ø 40	Ø 60
37'lik PVC Lamel		270 cm	265 cm	270 cm	265 cm	365 cm	332 cm
39'luk Alüminyum Lamel		265 cm	260 cm	265 cm	260 cm	350 cm	325 cm
55'li PVC - Alüminyum Lamel		178 cm	170 cm	178 cm	170 cm	260 cm	240 cm

* Lamel sarım ölçüleri kutu dahil hesaplanmıştır.



shutter solutions since 1984...

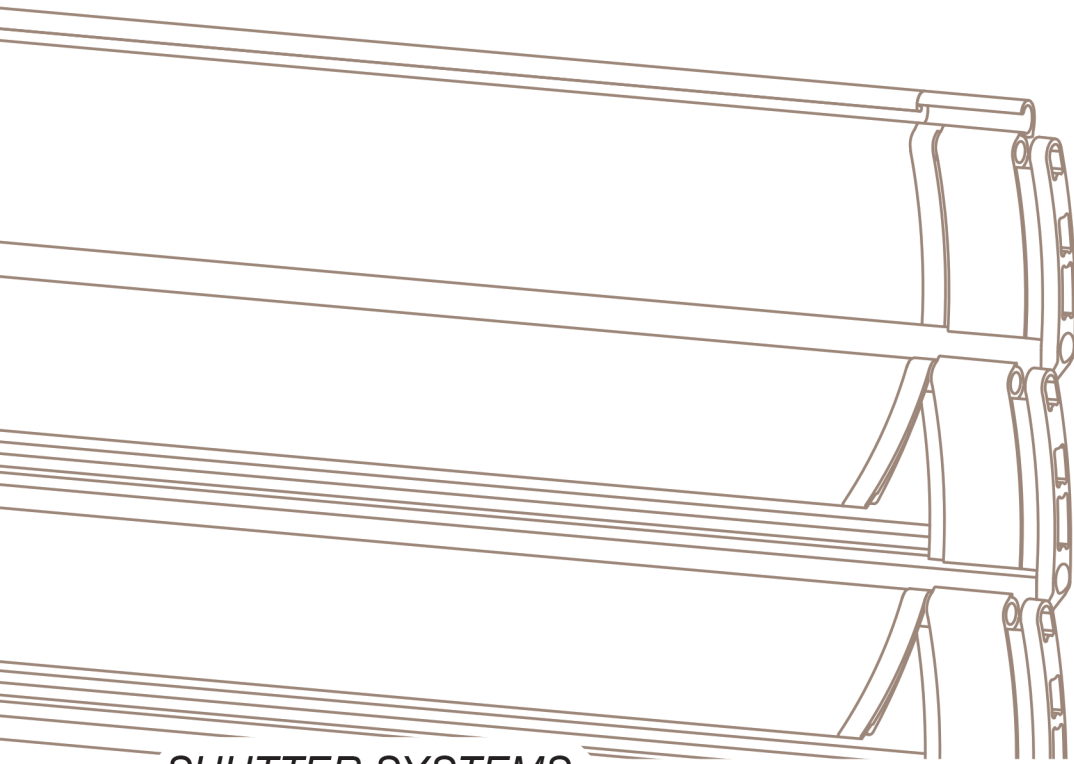

SHUTTER SYSTEMS

